

P | FLUX :



1.5HP CYCLONE
1 MICRON CANISTER | HEPA CANISTER

AGGVA



TABLE OF CONTENTS

- Important Safety Instructions
- Safety Guidelines - Definitions
- General Safety Rules
 - Additional Safety For Dust Collectors
 - Power Connections
 - Motor Specifications
 - Grounding Instructions
- Functional Description
- Product Specifications
- Unpacking
- Assembly
 - General Tool Assembly
- Maintenance Procedures
 - Cleaning the Filter
 - Changing the Filter Bag
 - Emptying the Drum
 - Routine Inspection
- Trouble Shooting
- Parts breakdown and Parts list



IMPORTANT SAFETY INSTRUCTIONS

⚠ WARNING

READ AND UNDERSTAND ALL WARNINGS AND OPERATING INSTRUCTIONS BEFORE USING THIS EQUIPMENT. Failure to follow all instructions listed below, may result in electric shock, fire, and/or serious personal injury or property damage.

Woodworking can be dangerous if safe and proper operating procedures are not followed. As with all machinery, there are certain hazards involved with the operation of the product. Using the machine with respect and caution will considerably lessen the possibility of personal injury. However, if normal safety precautions are overlooked or ignored, personal injury to the operator may result. Safety equipment such as guards, push sticks, hold-downs, featherboards, goggles, dust masks and hearing protection can reduce your potential for injury. But even the best guard won't make up for poor judgment, carelessness or inattention. **Always use common sense** and exercise caution in the workshop. If a procedure feels dangerous, don't try it. Figure out an alternative procedure that feels safer. **REMEMBER:** Your personal safety is your responsibility.

⚠ WARNING

This machine was designed for certain applications only. We strongly recommend that this machine not be modified and/or used for any application other than that for which it was designed. If you have any questions relative to a particular application, DO NOT use the machine until you have first contacted the manufacturer to determine if it can or should be performed on the product.

If you have any questions relative to its application DO NOT use the product until you have contacted the manufacturer and we have advised you.

When using an electrical appliance, basic precautions should always be followed, including the following:

READ ALL INSTRUCTIONS BEFORE USING (THIS APPLIANCE)

⚠ WARNING

To reduce the risk of fire, electric shock, or injury:

1. Do not leave appliance when plugged in. Unplug from outlet when not in use and before servicing.
2. Do not use outdoors or on wet surfaces
3. Do not allow to be used as a toy. Close attention is necessary when used by or near children.
4. Use only as described in this manual. Use only manufacturer's recommended attachments.
5. Do not use with damaged cord or plug. If appliance is not working as it should, has been dropped, damaged, left outdoors, or dropped into water, return it to a service center.



6. Do not pull or carry by cord, use cord as a handle, close a door on cord, or pull cord around sharp edges or corners. Do not run appliance over cord. Keep cord away from heated surfaces.
7. Do not unplug by pulling on cord. To unplug, grasp the plug, not the cord.
8. Do not handle plug or appliance with wet hands.
9. Do not put any object into openings. Do not use with any opening blocked; keep free of dust, lint, hair, and anything that may reduce air flow.
10. Keep hair, loose clothing, fingers, and all parts of body away from openings and moving parts.
11. Turn off all controls before unplugging.
12. Use extra care when cleaning on stairs.
13. Do not use to pick up flammable or combustible liquids, such as gasoline, or use in areas where they may be present.
14. Connect to a properly grounded outlet only. See Grounding Instructions.

SAVE THESE INSTRUCTIONS

1. Read and understand the warnings posted on the machine and in this manual. Failure to comply with all of these warnings may cause serious injury.
2. Replace the warning labels if they become obscured or removed.
3. This 1.5HP Portable Cyclone Dust Collector is designed and intended for use by properly trained and experienced personnel only. If you are not familiar with the proper and safe operation of this type of dust collector, do not use until proper training and knowledge have been obtained.
4. Do not use this machine for other than its intended use. If used for other purposes, **LAGUNA TOOLS INC.**, disclaims any real or implied warranty and holds itself harmless from any injury that may result from that use.
5. Always wear approved safety glasses/face shields while using this machine.
6. Before operating this dust collector, remove tie, rings, watches and other jewelry, and roll sleeves up past the elbows. Remove all loose clothing and confine long hair. Non-slip footwear or anti-skid floor strips are recommended. Do **not** wear gloves.
7. Wear ear protectors (plugs or muffs) during extended periods of operation.
8. Some dust created by power sanding, sawing, grinding, drilling and other construction activities contain chemicals known to cause cancer, birth defects or other reproductive harm. Some examples of these chemicals are:
 - Lead from lead based paint.
 - Crystalline silica from bricks, cement and other masonry products.
 - Arsenic and chromium from chemically treated lumber.



Your risk of exposure varies, depending on how often you do this type of work. To reduce your exposure to these chemicals, work in a well-ventilated area and work with approved safety equipment, such as face or dust masks that are specifically designed to filter out microscopic particles.

9. Do not operate this machine while tired or under the influence of drugs, alcohol or any medication.
10. Make certain the switch is in the **OFF** position before connecting the machine to the power source.
11. Make certain the machine is properly grounded.
12. Make all machine adjustments or maintenance with the machine unplugged from the power source.
13. Form a habit of checking to see that all extra equipment such as adjusting keys, wrenches, scrap, stock, and cleaning rags are removed away from the machine before turning on.
14. Keep safety guards in place at all times when the machine is in use. If removed for maintenance purposes, use extreme caution and replace the guards immediately when maintenance is complete.
15. Make sure the dust collector is on a flat even surface and the wheels locked in place before use.
16. Check damaged parts. Before further use of the machine, a guard or other part that is damaged should be carefully checked to determine that it will operate properly and perform its intended function. Check for alignment of moving parts, binding of moving parts, breakage of parts, mounting and any other conditions that may affect its operation. A guard or other part that is damaged should be properly repaired or replaced.
17. Provide for adequate space surrounding work area and non-glare, overhead lighting.
18. Keep the floor around the machine clean and free of scrap material, oil and grease.
19. Keep visitors a safe distance from the work area. **Keep children away.**
20. Make your workshop child proof with padlocks, master switches or by removing starter keys.
21. Give your work undivided attention. Looking around, carrying on a conversation and "horse-play" are careless acts that can result in serious injury.

LAGUNA

22. Maintain a balanced stance at all times so that you do not fall or lean against the dust collector. Do not overreach or use excessive force to perform any machine operation.
23. Use the right tool at the correct speed and feed rate. Do not force a tool or attachment to do a job for which it was not designed. The right tool will do the job better and safer.
24. Use recommended accessories; improper accessories may be hazardous.
25. Maintain machinery with care. Follow instructions for lubricating and changing accessories.
26. Turn off the machine before cleaning. Use a brush or compressed air to remove dust or debris — do not use your hands.
27. Do not stand on the machine. Serious injury could occur if the machine tips over.
28. Never leave the machine running unattended. Turn the power off and do not leave the machine until it comes to a complete stop.
29. Never operate or run the machine without closing the drum up against the lid. Failure to do so will result in the machine amperage increasing and may trip your circuit.

Familiarize yourself with the following safety notices used in this manual:

SAFETY GUIDELINES - DEFINITIONS

This manual contains information that is important for you to know and understand. This information relates to protecting YOUR SAFETY and PREVENTING EQUIPMENT PROBLEMS. To help you recognize this information, we use the symbols below. Please read the manual and pay attention to these sections.



Indicates an imminently hazardous situation which, if not avoided, will result in death or serious injury.



Indicates a potentially hazardous situation which, if not avoided, could result in death or serious injury.



Indicates a potentially hazardous situation which, if not avoided, may result in minor or moderate injury.

LAGUNA

⚠ CAUTION

Used without the safety alert symbol indicates potentially hazardous situation which, if not avoided, may result in property damage.

GENERAL SAFETY RULES

⚠ WARNING

WARNING FAILURE TO FOLLOW THESE RULES MAY RESULT IN SERIOUS PERSONAL INJURY.

FOR YOUR OWN SAFETY, READ AND UNDERSTAND THE INSTRUCTION MANUAL BEFORE OPERATING THE MACHINE. Learn the unit's application and limitations as well as the specific hazards peculiar to it.

KEEP WORK AREA CLEAN. Cluttered areas and benches invite accidents.

DON'T USE IN DANGEROUS ENVIRONMENT. Don't use this unit in damp or wet locations, or expose it to rain. Keep work area well-lighted.

KEEP CHILDREN AND VISITORS AWAY. All children and visitors should be kept a safe distance from work area.

DISCONNECT UNIT before servicing.

CHECK DAMAGED PARTS. Before further use of the unit, properly repair or replace any part that is damaged.

⚠ WARNING

FAILURE TO FOLLOW THESE RULES MAY RESULT IN SERIOUS INJURY.

ADDITIONAL SAFETY FOR DUST COLLECTORS

Intended use. This dust collector is only intended for collecting wood dust and chips from woodworking machines. Do not use this dust collector to collect metal, dirt, pebbles, drywall, asbestos, lead paint, silica, liquids, aerosols, or any flammable, combustible, or hazardous materials.

Hazardous dust. Dust created while using machinery may cause cancer, birth defects, or long-term respiratory damage. Be aware of dust hazards associated with each work piece material, and always wear a NIOSH-approved respirator to reduce your risk.



Dust allergies. Dust from certain woods may cause an allergic reaction in people and animals.

Make sure you know what type of wood dust you will be exposed to in case there is a possibility of an allergic reaction.

Wear respirator. Fine dust that is too small to be caught in the filter will be blown into the ambient air during operation. Always wear a NIOSH-approved respirator during operation and for a short time after to reduce your risk of permanent respiratory damage.

Emptying dust. When emptying dust from the collection container, wear a respirator and safety glasses. Empty dust away from ignition sources and into an approved container.

Disconnecting power supply. Turn the switch off, disconnect the dust collector from the power supply, and allow the impeller to come to a complete stop before leaving the machine unattended or doing any service, cleaning, maintenance, or adjustments.

Suspended dust particles and ignition sources. Do not operate the dust collector in areas where explosion risks are high. Areas of high risk include, but are not limited to, areas near pilot lights, open flames, or other ignition sources.

Fire suppression. Only operate the dust collector in locations that contain a fire suppression system or have a fire extinguisher nearby.

Impeller hazards. Do not place your hands or tools near the open inlet during operation for any reason. The powerful suction could easily cause accidental contact with the impeller, which will cause serious personal injury or damage to the machine. Always keep small animals and children away from open dust collection inlets.

Avoiding sparks. Do not allow steel or rocks to strike the impeller—this may produce sparks.

Sparks can smolder in wood dust for a long time before a fire is detected. If you accidentally cut

into wood containing tramp metal (nails, staples, spikes, etc.), immediately turn **off** the dust collector, disconnect it from power, and wait for the impeller to stop—then empty the collection container into an approved airtight metal container.

Operating location. To reduce respiratory exposure to fine dust, locate permanently installed dust collectors away from the working area, or in another room that is equipped with a smoke detector. Do not operate the dust collector in rainy or wet locations—exposure to water may create a shock hazard or decrease the life of the machine.

Static electricity. Plastic dust lines generate high amounts of static electricity as dust chips pass through them. Although rare, sparks caused by static electricity can cause explosions or fire. To reduce this risk, make sure all dust lines are thoroughly grounded by using a grounding wire.

LAGUNA

Regular cleaning. Regularly check/empty the collection bags or drum to avoid the buildup of fine dust that can increase the risk of fire. Make sure to regularly clean the surrounding area where the machine is operated—excessive dust buildup on overhead lights, heaters, electrical panels, or other heat sources will increase the risk of fire.

CAUTION

This means that if precautions are not heeded, it may result in minor injury and/or possible machine damage.

WARNING

This means that if precautions are not heeded, it may result in serious injury or possibly even death.

SAVE THESE INSTRUCTIONS.
Refer to them often and use them to instruct others.

POWER CONNECTIONS

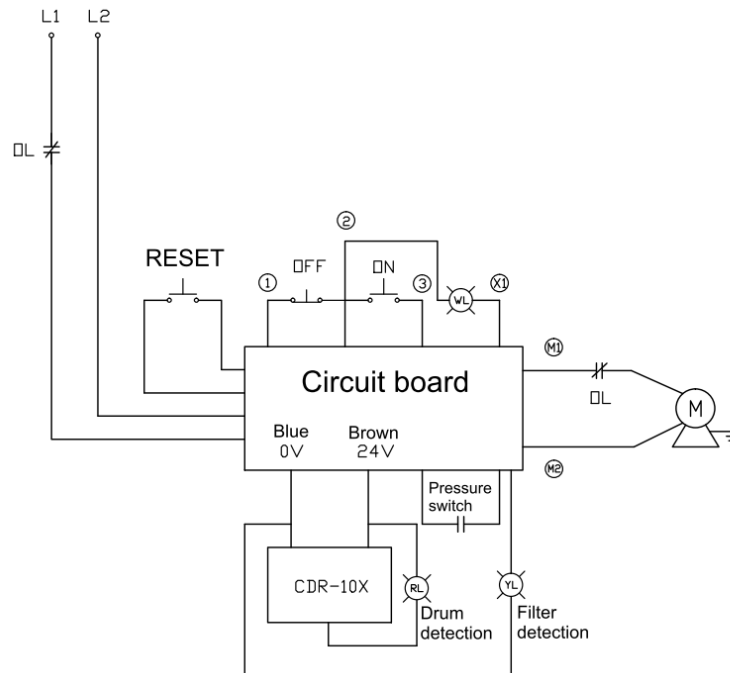

DANGER

DO NOT EXPOSE THE MACHINE TO RAIN OR OPERATE THE MACHINE IN DAMP LOCATIONS.



MOTOR SPECIFICATIONS

Your machine is wired for 240volts, 50 HZ alternating current. Before connecting the machine to the power source, make sure the switch is in the "OFF" position.

GROUNDING INSTRUCTIONS



THIS MACHINE MUST BE GROUNDED WHILE IN USE TO PROTECT THE OPERATOR FROM ELECTRIC SHOCK.

1. This appliance must be connected to a grounded metal, permanent wiring system; or an equipment-grounding conductor must be run with the circuit conductors and connected to the equipment-grounding terminal or lead on the appliance.

The installer, such as a qualified electrician, cut (or bend over) and insulate the grounding conductor from a field wiring supply cable.

In the event of certain types of malfunctions or breakdowns, grounding provides a path of least resistance for electric current—in order to reduce the risk of electric shock.

Improper connection of the equipment-grounding wire can result in a risk of electric shock. The wire with green insulation (with or without yellow stripes) is the equipment-grounding wire. If repair or replacement of the power cord or plug is necessary, do not connect the equipment-grounding wire to a live (current carrying) terminal.

Check with a qualified electrician or service personnel if you do not understand these grounding requirements, or if you are in doubt about whether the tool is properly grounded. If you ever notice that a cord or plug is damaged or worn, disconnect it from power, and immediately replace it with a new one.

Full Load amperage Draw

Amp draw at 240V (prewired)..... 9 Amps

Power Supply Circuit Requirements

The power source circuit for your machine must be grounded and rated for the amperage given below. Never replace a circuit breaker on an existing circuit with one of higher amperage without consulting a qualified electrician to ensure compliance with wiring codes. **If you are unsure about the wiring codes in your area or you plan to connect your machine to a shared circuit, consult a qualified electrician.**

Circuit Size (240V)..... 15 Amps

LAGUNA

⚠ DANGER

IN ALL CASES, MAKE CERTAIN THE RECEPTACLE IN QUESTION IS PROPERLY GROUNDED. IF YOU ARE NOT SURE, HAVE A QUALIFIED ELECTRICIAN CHECK THE RECEPTACLE.

240 VOLT Single-Phase Operation

The motor supplied with your machine is a single voltage, 240 volt motor. It is shipped ready-to-run for 240 volt operation.

FUNCTION

High frequency remote control switch

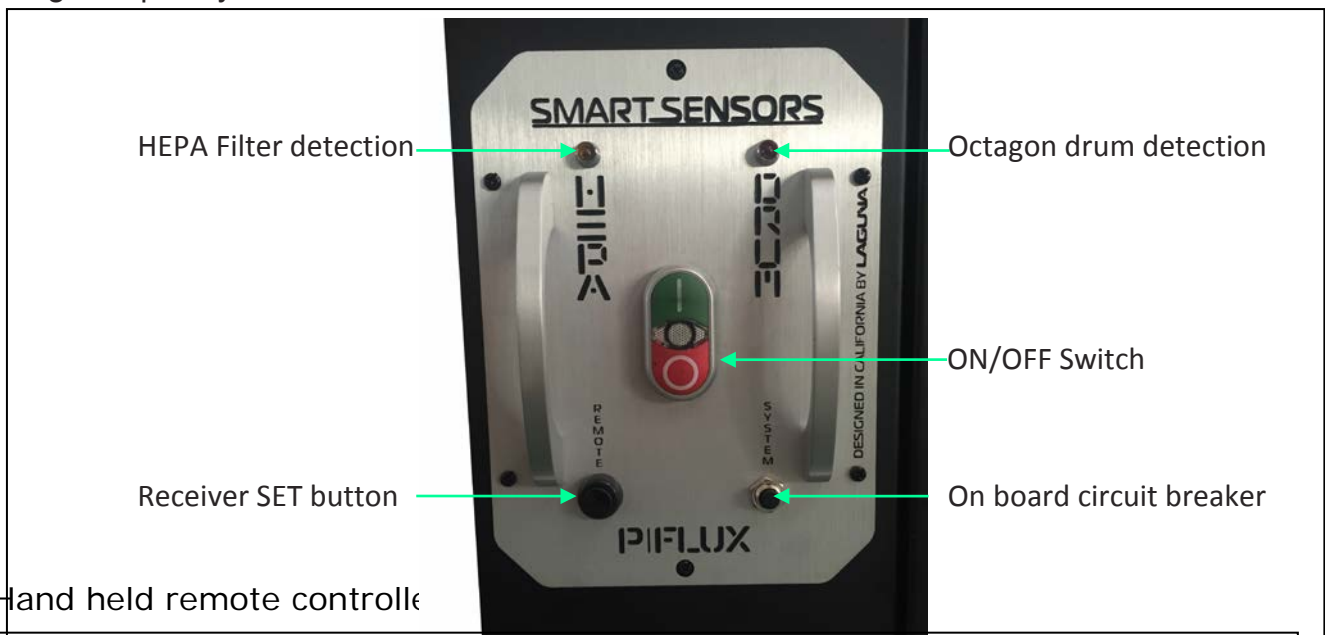

Hand held remote controller



*Used to match up a new hand held controller with the remote switch

LAGUNA

PROGRAMMING THE REMOTE CONTROL

1. Ensure the machine is switch ON before programming the remote control.
2. Press the Black Receiver set button on the bottom of the remote switch until you hear two beeps.
3. Press the Remote set button on your hand held controller simultaneously with the RED button until you hear three beeps to complete the set up.

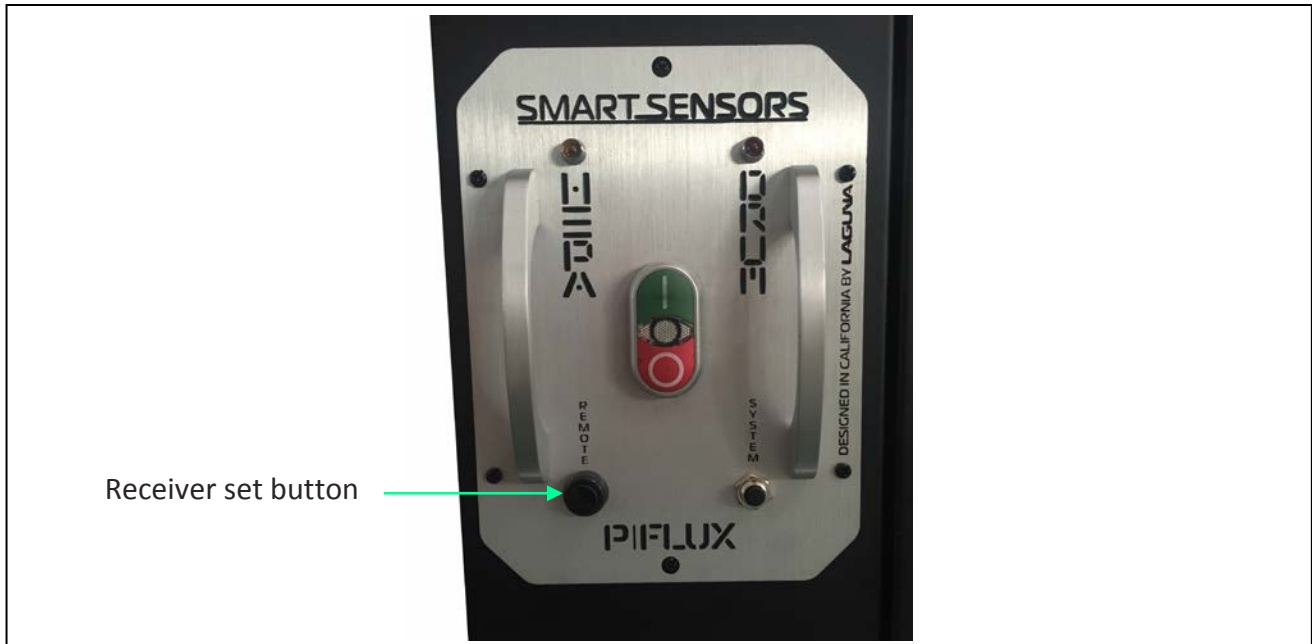



PRODUCT SPECIFICATIONS

Motor	1100w (1.5hp)
Power Supply	220-240V / 50Hz / 1PH
Running Amp	(with 6" inlet) 9A @ 240v
Recommended Breaker Size (MCB)	20 Amps (Type D)
Airflow (Traditional Method)	1786m ³ /hour (1051cfm)
Airflow (Realistic Method)	1224m ³ /hour (720cfm)
Max. Static Pressure	256mm in water (10.1")
Fan Diameter	340mm (13.5")
Inlet Diameter	1x 150mm or 2 x 100mm (1 x 6" or 2 x 4")
Switch	High frequency remote control switch
Noise Level	70 dB(A) @ 3m
Drum Collection Capacity	145 Litre octagonal drum
Packing Size (WxDxH)	1170 x 600 x 1750mm
Machine Weight (Net Weight)	122kg
Shipping Weight (Gross Weight)	150kg
Filter Media	Filtering area: 4.5m ² (48ft ²)
Cartridge Filter	400mm diameter x 500mm height
Filtration Size	HEPA 99.2% @ 0.4 micron
Drum Collection Bag Layflat Size	810 x 1090mm (32" x 43")
Filter Collection Bag Layflat Size	N/A





Woodworking machinery at its best!

Declaration of Conformity for CE Marking

Charnwood Machinery Ltd
Cedar Court
Walker Road
Bardon Hill
Leicestershire
LE67 1TU
England

Declare that Industrial Dust Collector & Air Cleaner
Models B Flux, C Flux1, C Flux3, P Flux1, P Flux3

Conforms with the following Directives:

Machinery Directive 2006/42/EC

And further conforms with the following EU harmonized standard;

EN ISO 12100:2010, EN 60204-1:2006/AC:2010

I hereby declare that equipment named above has been tested and found to comply with the relevant sections of the above referenced specifications. The machinery complies with all essential requirements of the directive.

Signed: Richard Cook

Dated: 09/11/2017

Location: Leicestershire

Richard Cook
Director



Tel. 01530 516926 Fax. 01530 516929 email; sales@charnwood.net
Website: www.charnwood.net VAT GB 290 2170 80
Charnwood Machinery Ltd, Cedar Court, Walker Road, Bardon Hill,
Leicestershire, LE67 1TU, England
Registration No:1316450

LAGUNA

UNPACKING

Your 1.5HP Mobile Dust Cyclone comes packed in a single box. Before attempting to assemble this machine, follow these directions for unpacking:

1. Carefully cut the banding straps and remove them from the box.
2. Cut along the tape line at the top of the box.
3. Remove all parts from the top of the styrofoam and set aside.
4. Remove the styrofoam packing material from the top of the machine.
5. Carefully take out the machine components from the box and set aside.
6. Using the diagram below ensure that all parts are present and in good condition.

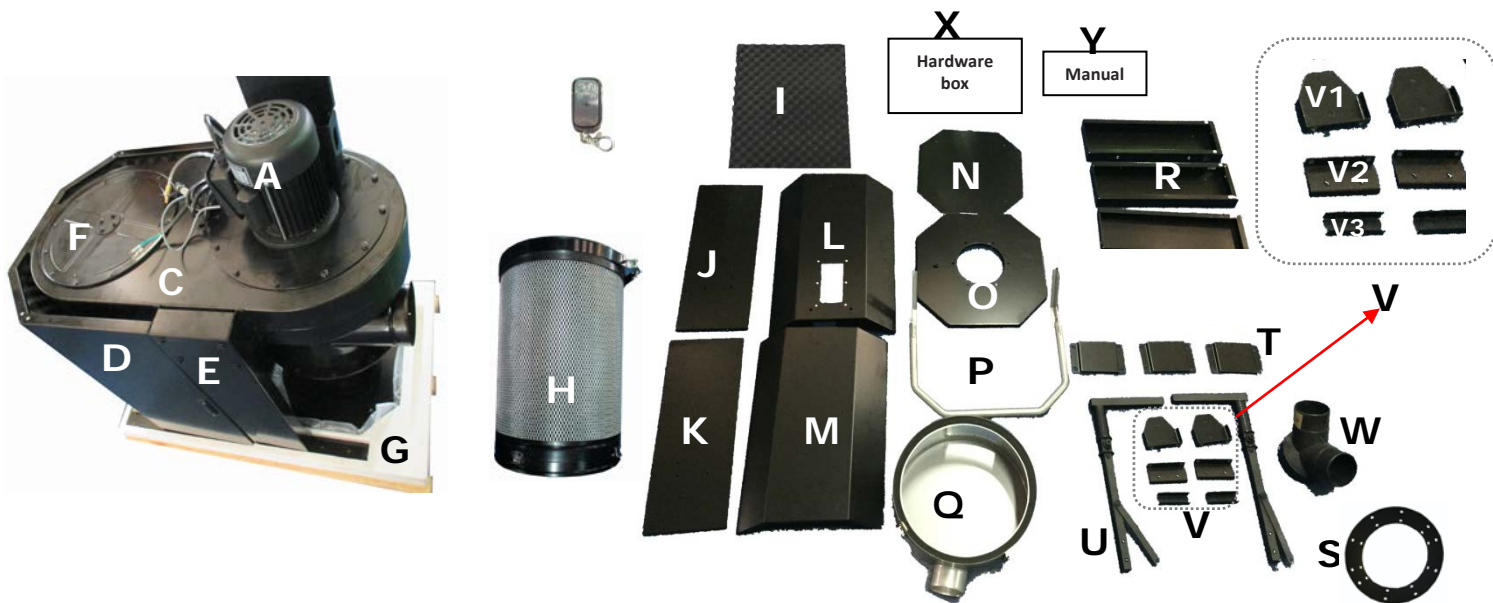

DESCRIPTION (QUANTITY) Figure 1

- | | |
|-------------------------------------|--|
| A. Motor | O. Octagon drum lid |
| B. Switch and remote controller | P. Octagon drum foot peddle |
| C. Dust chute | Q. Canister end cap with 4" port |
| D. Canister shield (front and back) | R. Lower upright supports (3) |
| E. Top upright supports (3) | S. Vacuum suction ring |
| F. Canister cover plate | T. Upright support reinforcement plate (3) |
| G. Base frame | U. Foot peddle bar (left and right) |
| H. HEPA Canister filter | V. Foot peddle assembly fittings |
| I. Canister shield (side) | V1. Lower triangular support plate (2) |
| J. Octagon drum left panel | V2. Foot peddle bar support (2) |
| K. Octagon drum right panel | V3. Lower support plate (2) |
| L. Octagon drum front panel | W. Inlet adapter |
| M. Octagon drum back panel | X. Hardware box |
| N. Octagon drum base panel | Y. Operating and Parts Manual |

Report any missing or damaged parts to your dealer or distributor. Prior to tool assembly and use, read this manual thoroughly to familiarize yourself with proper assembly, maintenance and safety procedures.

LAGUNA

GENERAL TOOL ASSEMBLY

⚠ WARNING

This step requires two adults. This 1.5 HP Mobile Dust Cyclone is heavy, be careful when lifting and handling it! Failure to comply may cause serious injury and/or damage to the machine and/or property!

Tools Required

10mm wrench / 12mm wrench / 14mm wrench

Phillips screwdriver

4mm hex wrench / 5mm hex wrench

To assemble your dust cyclone, follow these steps:

For your own safety, do not connect the machine to the power source until the machine is completely assembled. Please also make sure that you read and understand the entire instruction manual.

ASSEMBLY TIME ESTIMATE 5 hour to 6 hours

Step One: Turn the unit upside down. Make sure you use a cushion under the canister top side to even out the unit to the same height as the motor. Do not have the unit lopsided.

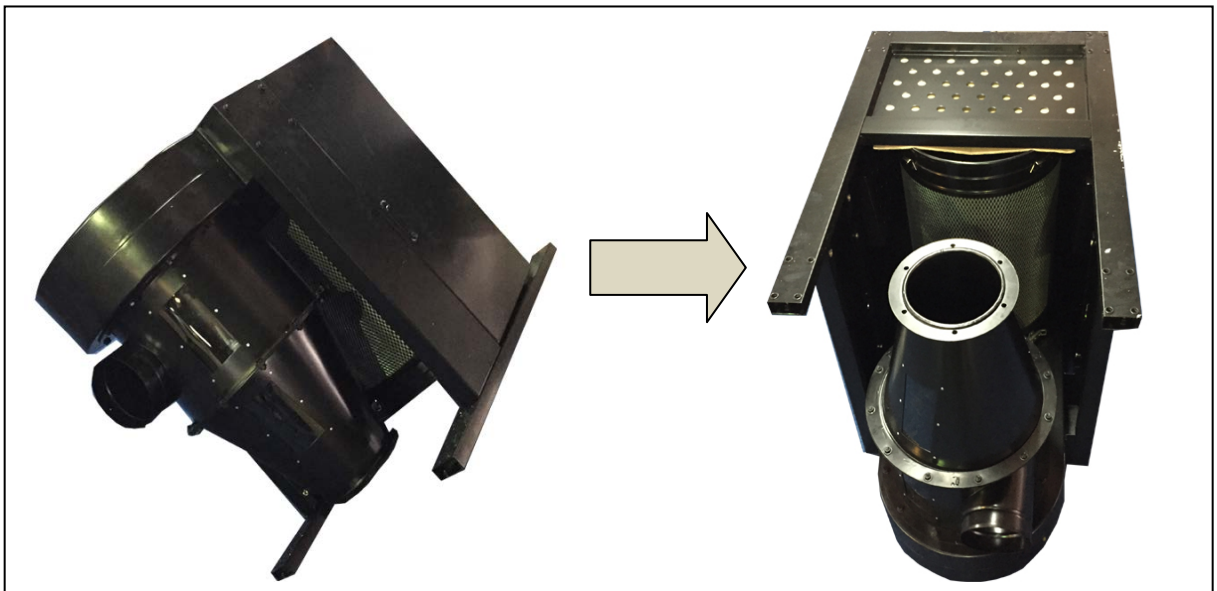

LAGUNA

Step Two: Remove the base which has been fastened to the (3) top upright supports.

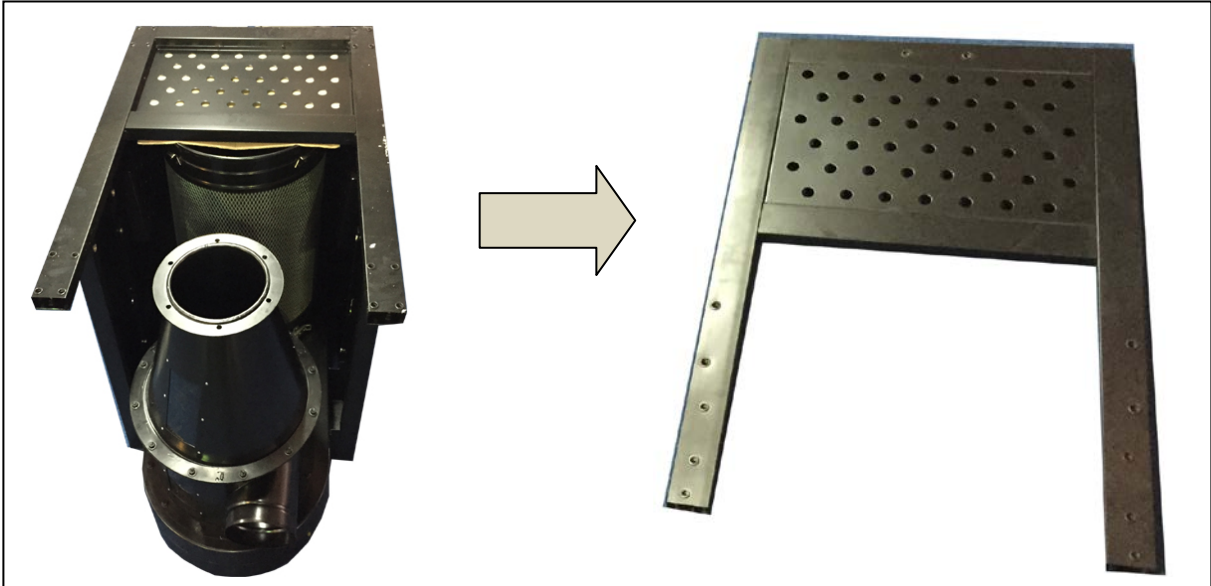

Step Three: Secure the (4) 4" wheels to the underside of the base using (16) 5/16" x 3/4" hex bolts and (16) 5/16" x od18 x 2T flat washers.

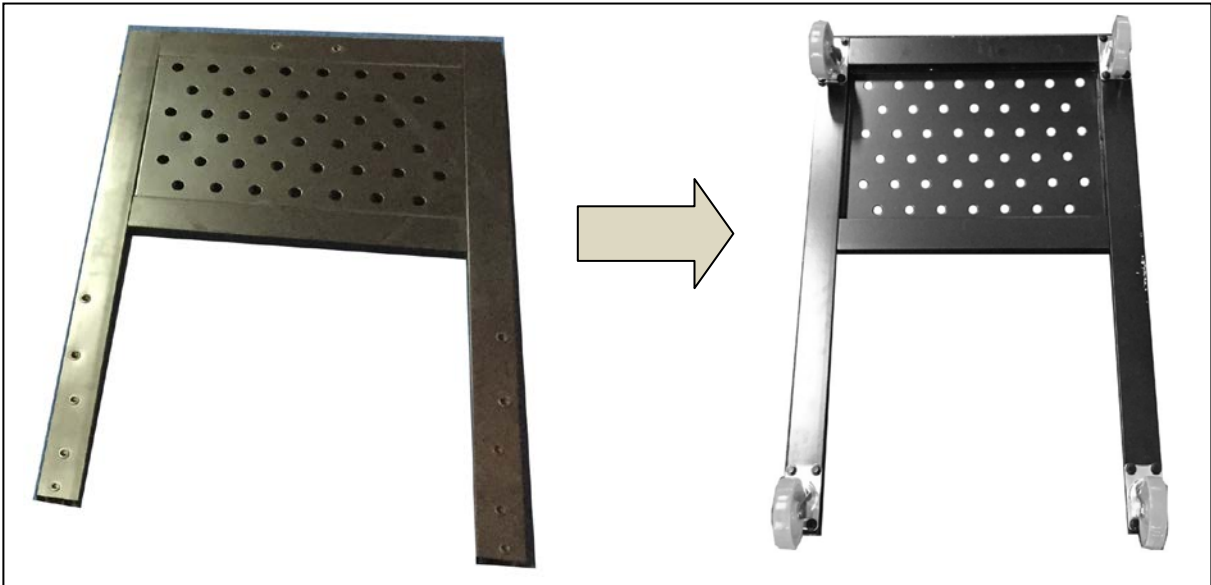

LAGUNA

Step Four: Turn the base around with it standing on the (4) 4" wheels and secure the three lower upright support panels using (6) 3/8"*3/4" hex bolts and (6) 3/8"*OD23*2t flat washers.

Each lower upright support panels numbered for its specific location.

A – shown with one dot is located on the canister side.

B – shown with two dots is located on the front side

C – shown with three dots is located on the opposite end.

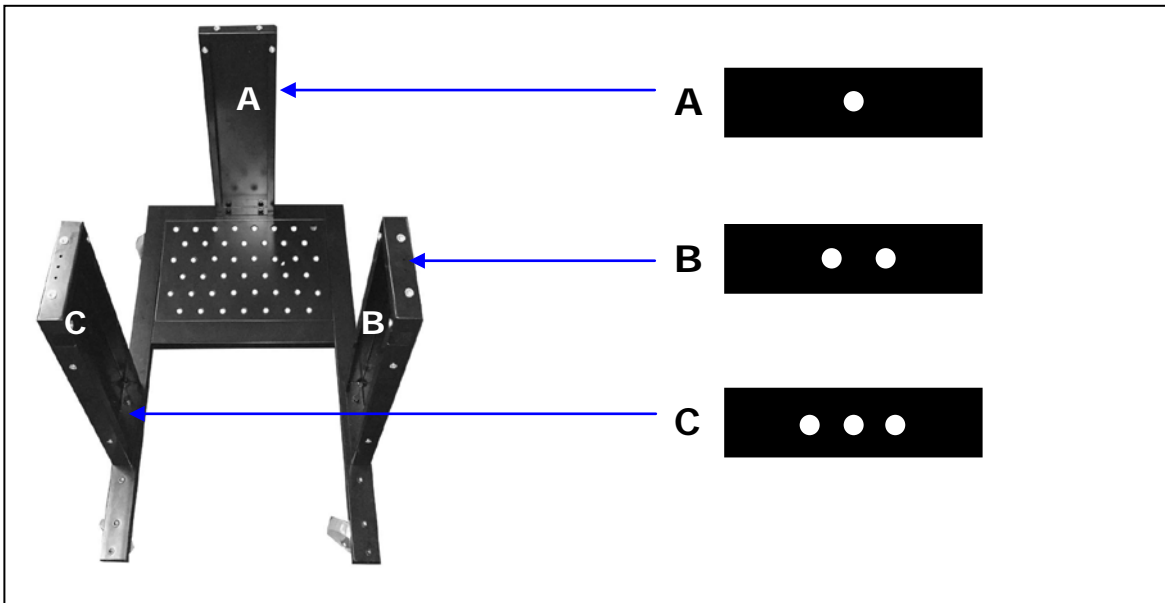

Step Five: Unbuckle the clamp holding the canister to the dust chute. Remove the canister filter and set aside.

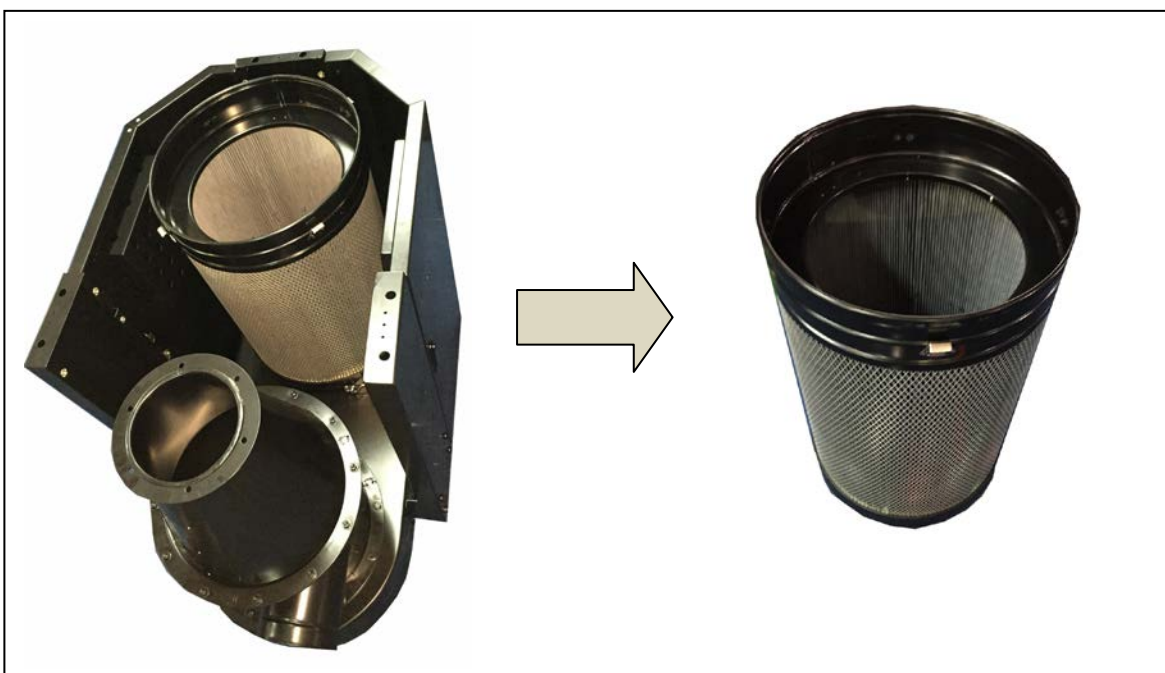

LAGUNA

Step Six: Secure the base with (3) lower upright support panels to the unit using (6) 5/16"×3/4" hex bolts and (6) 5/16"×OD18*2t flat washers.



Step Seven: Secure the (3) upright support reinforcement plates using (12) 5/16"×3/4" hex bolts and (12) 5/16"×OD18*2t flat washers.

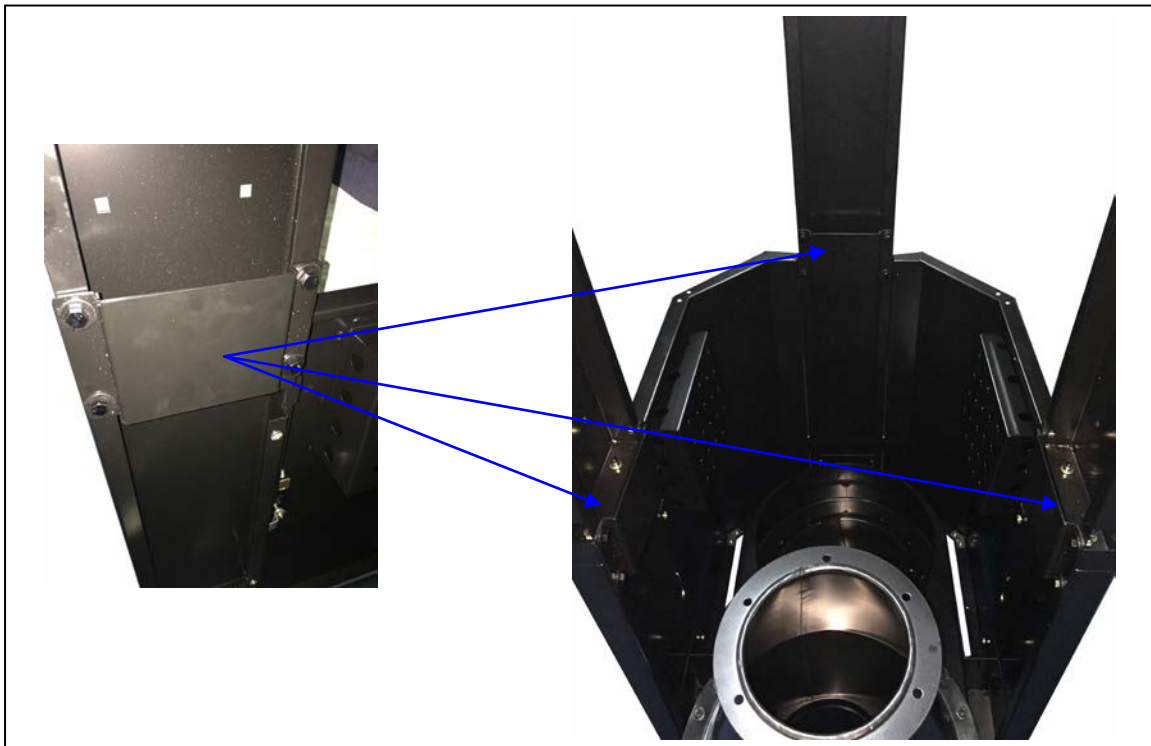

LAGUNA

Step Eight: With the help of another person, lift the unit up carefully to the right side up with the motor on top and the wheels at the bottom.

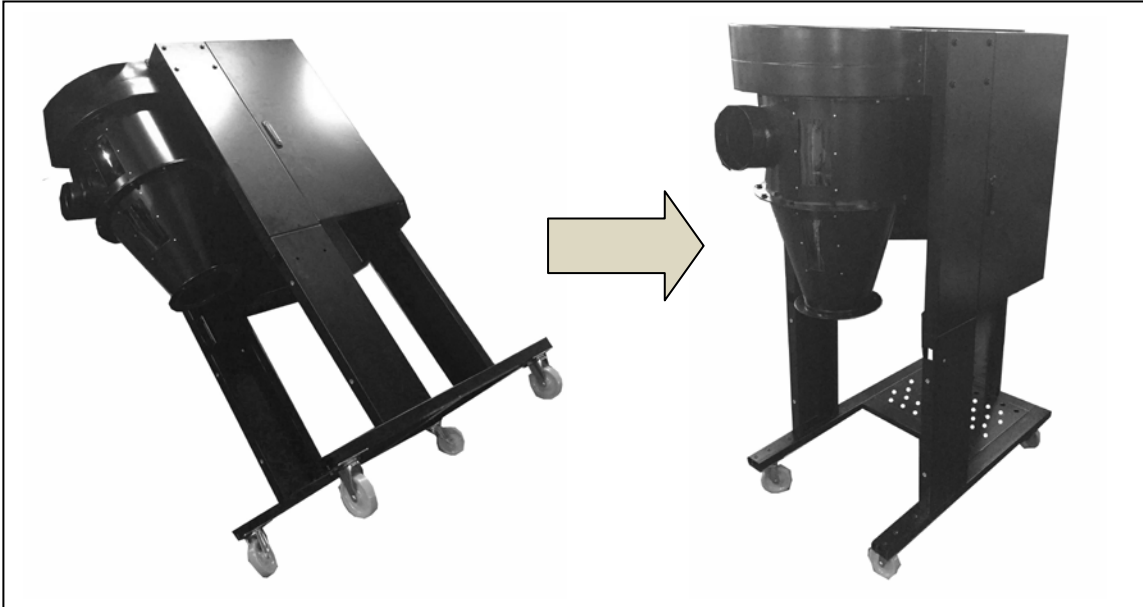

Step Nine: Attach the canister filter back in place and secure with clamp. It does not matter which side you choose to position the clamp.



LAGUNA

Step Ten: Attach the canister filter end cap to the canister filter using the (4) latches. Cover the 4" hook up with the 4" rubber plug.



Step Eleven: Secure the lower triangular support plate to the base using (2) 5/16" x 3/4" hex bolts and (2) 5/16" x OD18 x 2t flat washers. Follow the same steps for the opposite side.

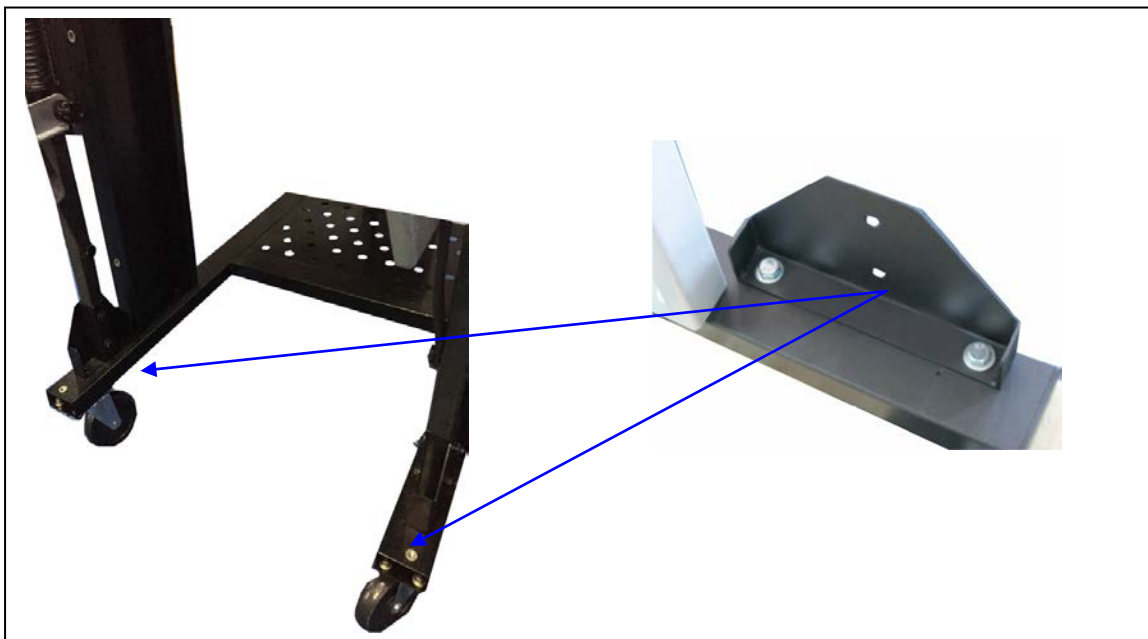

LAGUNA

Step Twelve: Locate the two foot pedal bars provided. There is a left side and right side. To identify the correct side, look for the protruding nut, circled in red below. It should be facing upwards when you place the bars on the floor.

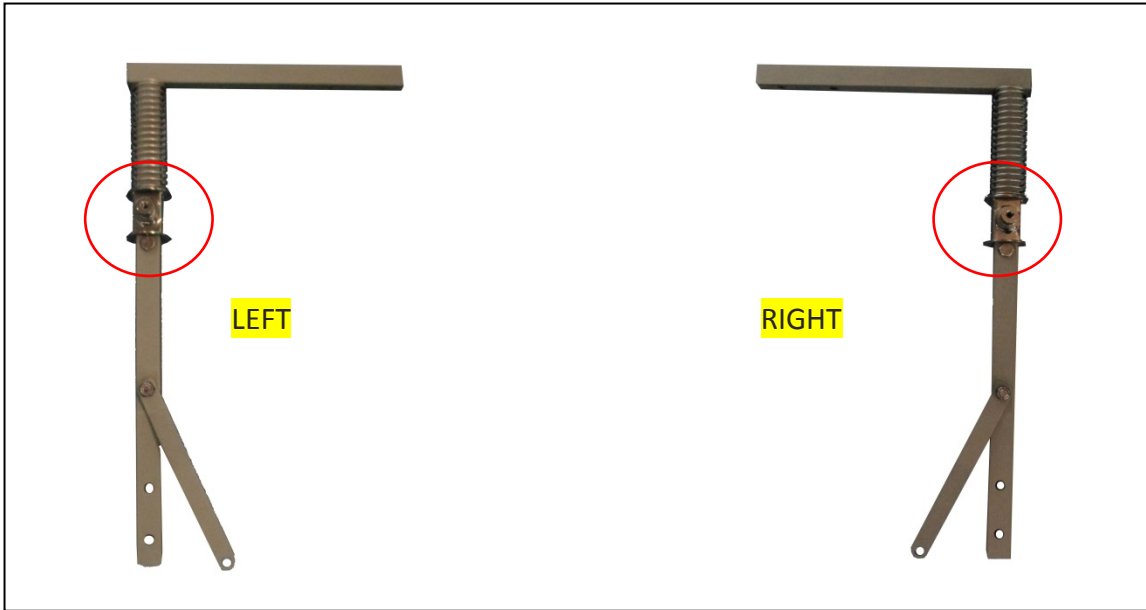

Step Thirteen: Ensure that the foot pedal bar is the correct side and slide the Foot pedal bar into the opening on the lower upright support panel. Make sure the end of the bar is on the inside of the triangular support plate. Follow the same steps for the opposite side.



LAGUNA

Step Fourteen: Secure the foot pedal support to the lower upright support panel using (4) 5/16"×1/2" carriage bolts, (4) 5/16"×OD18*2t flat washers and (4) 5/16" hex nuts. Then secure the foot pedal bar to this support using (4) 5/16"×1-3/4" hex bolts, (8) 5/16"×OD18*2t flat washers and (4) 5/16" hex nuts. Follow the same steps for the opposite side.

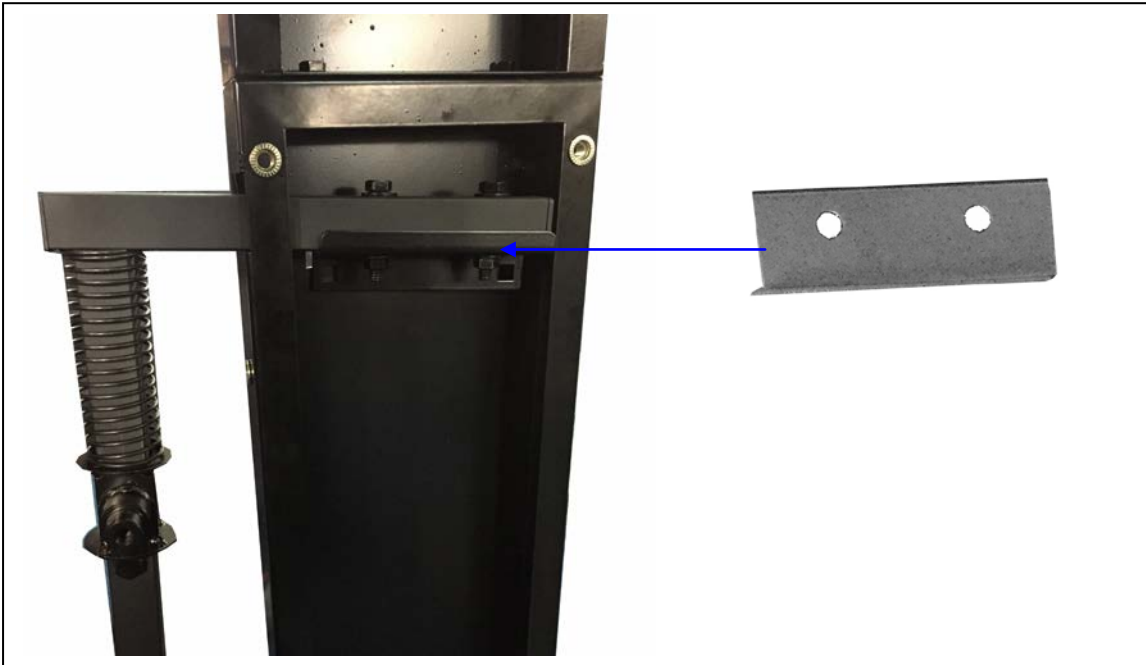

Step Fifteen: Secure the base of the foot pedal bar to the triangular support plate by holding the lower support plate vertically up against the foot pedal bar and securing the U channel provided onto the foot pedal bar using (2) 5/16"×1-3/4" hex bolts, (4) 5/16"×OD18*2t flat washers and (2) 5/16" hex nuts from the inside out. Follow the same steps for the opposite side.

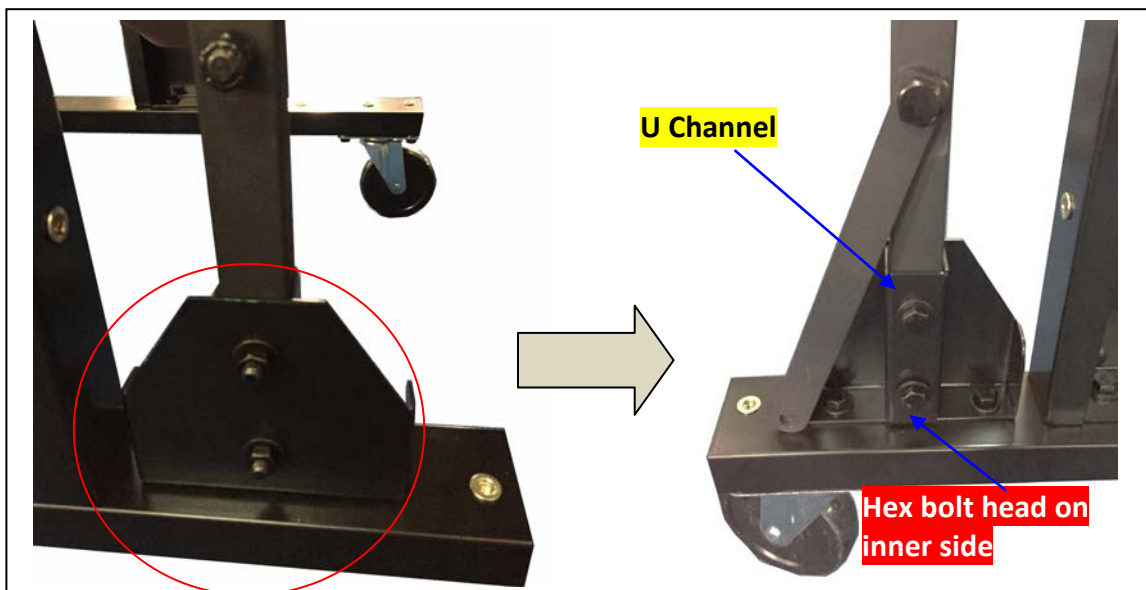

LAGUNA

Step Sixteen: Attach the cover plate over the foot pedal assembly. Secure using (6) 1/4"×3/4" hex bolts and (6) 1/4"×OD19*2t flat washers. Follow the same steps for the opposite side.



Step Seventeen: Attach the two ends of the Octagon foot pedal to the nut on the foot pedal bar

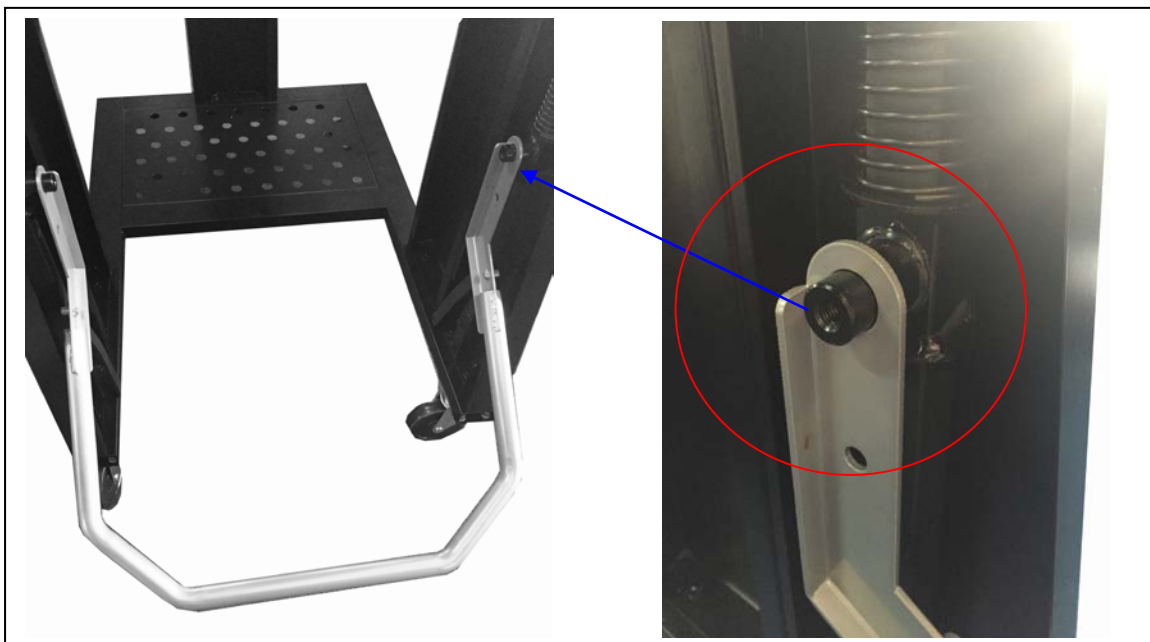

LAGUNA

Step Eighteen: Secure the topping to the nut on the foot peddle bar. Follow this step on the opposite side.

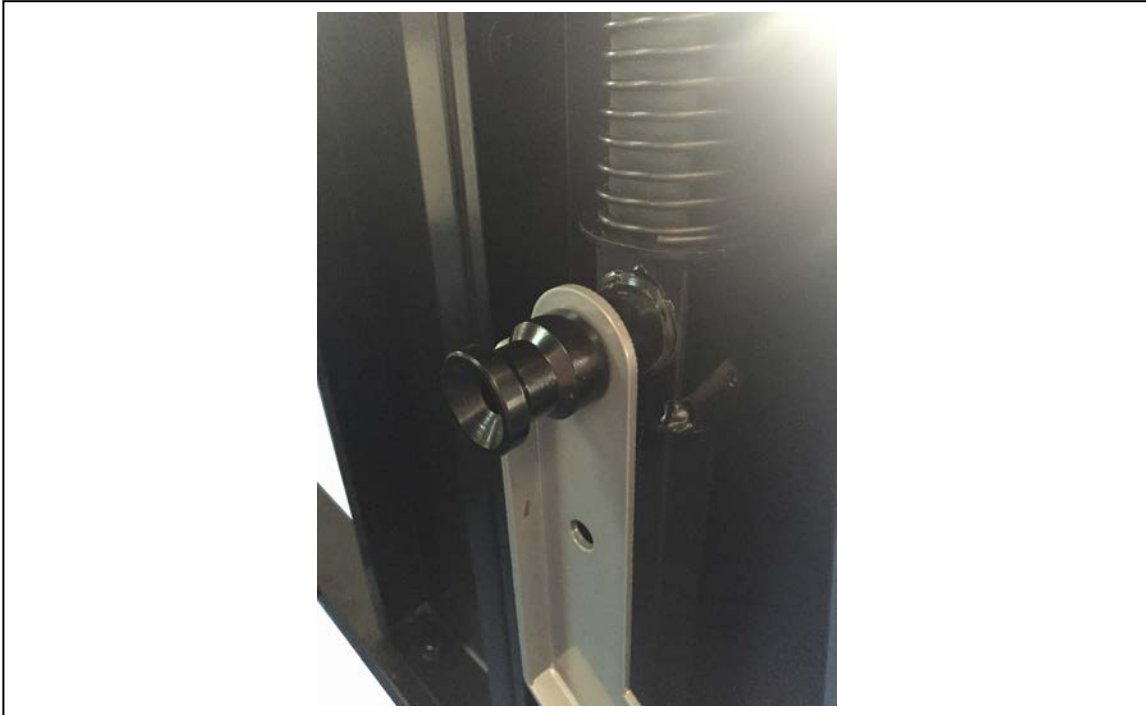

Step Nineteen: Secure the topping with (2) M8*30mm hex bolts.

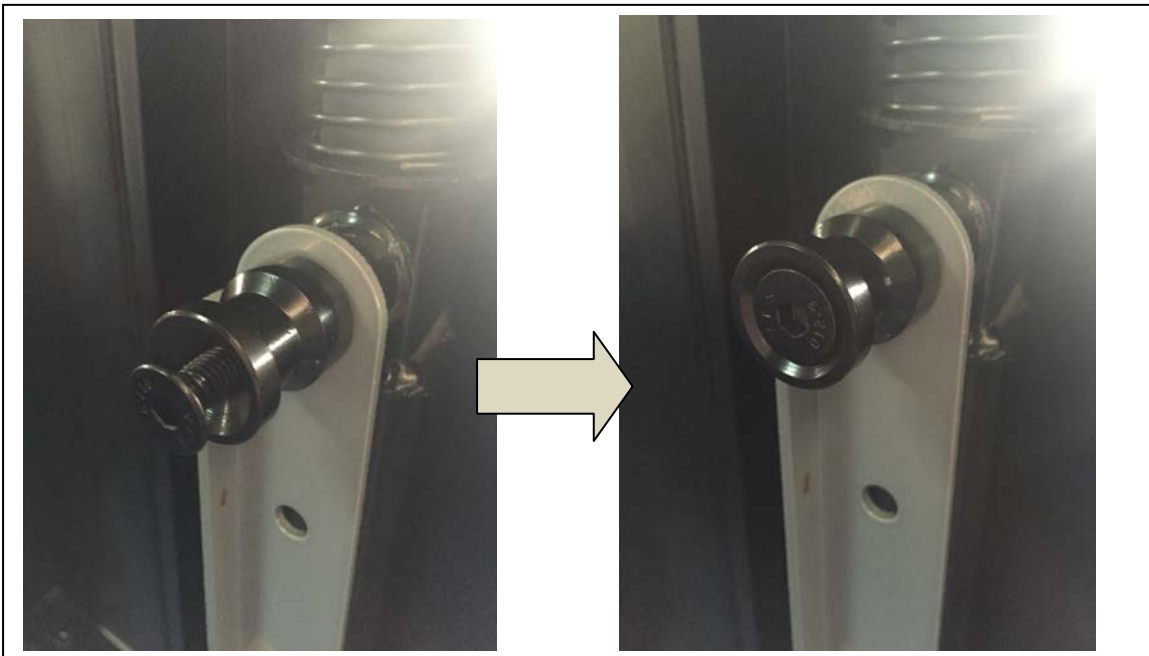

LAGUNA

Step Twenty: Align the bolt hole on the movable supporting brace on the foot peddle bar with the bolt hole on the octagon foot peddle.

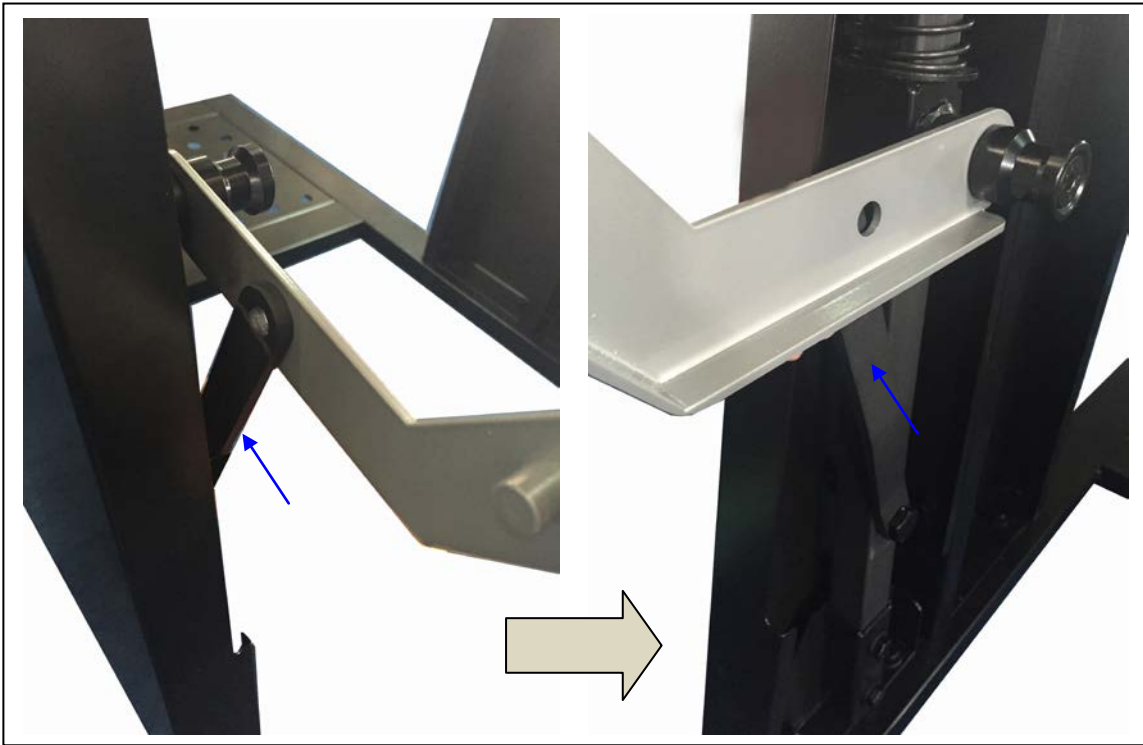

Step Twenty One: Secure the movable supporting brace on the foot peddle bar with the octagon foot peddle using (2) 3/8"*21mm hex bolts. Make sure the bolt head is on the inside of the octagon foot peddle. Adjust the tightness of this bolt accordingly. If this bolt is too tight, the Octagon foot peddle will not work smoothly. When too loose it will not pick up the Octagon drum.



LAGUNA

Step Twenty Two: Apply foam tape to the cone flange before attaching the drum lid. Secure the Octagon drum lid to the cyclone funnel using (6) 5/16"×3/4" hex bolts, (12) 5/16"×OD18×2t flat washers and (6) 5/16" hex nuts. Make sure to first attach all the bolts on before tightening the bolts. **The lid will turn when the bolts have not been tightened for alignment.** Failure to do so will result in the drum lid not being able to align with the drum.



Step Twenty Three: Attach the full drum detection sensor to the opening on the drum lid located behind the cyclone funnel. When securing the sensor make sure the end of the sensor is not longer than the drum lid rim. If it extends longer than the rim, the detection will not function correctly.

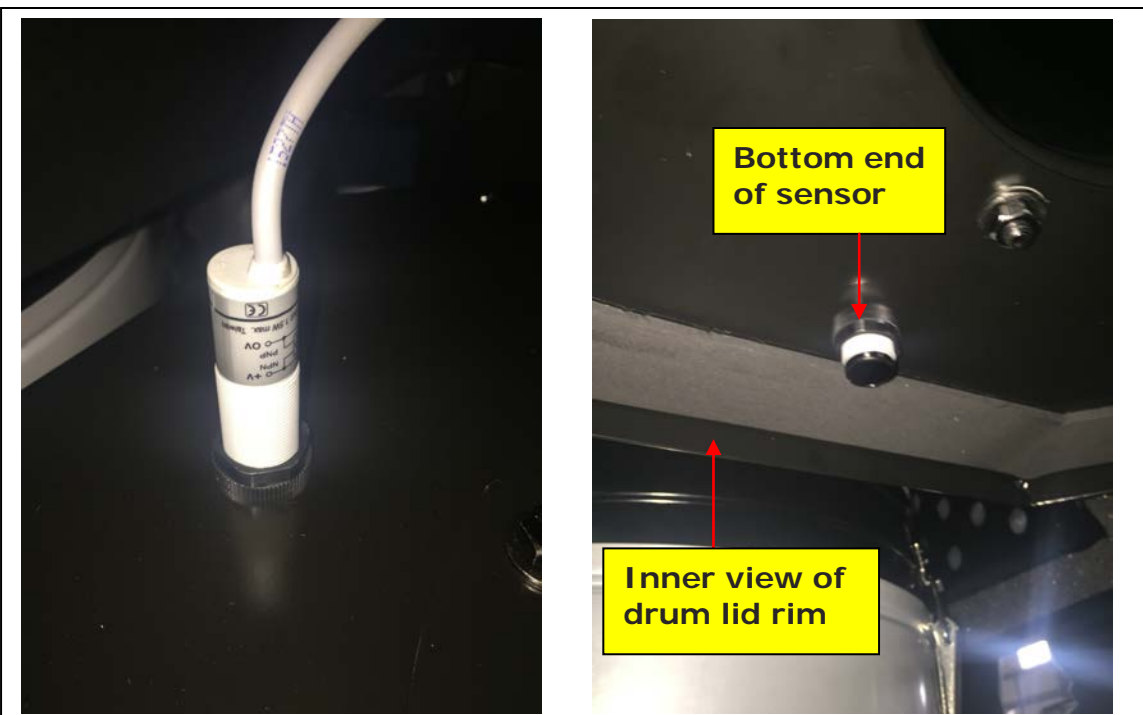

LAGUNA

Step Twenty Four: To adjust the distance of the sensor to detect the dust waste level use the white plastic pin that was provided in the hardware box.

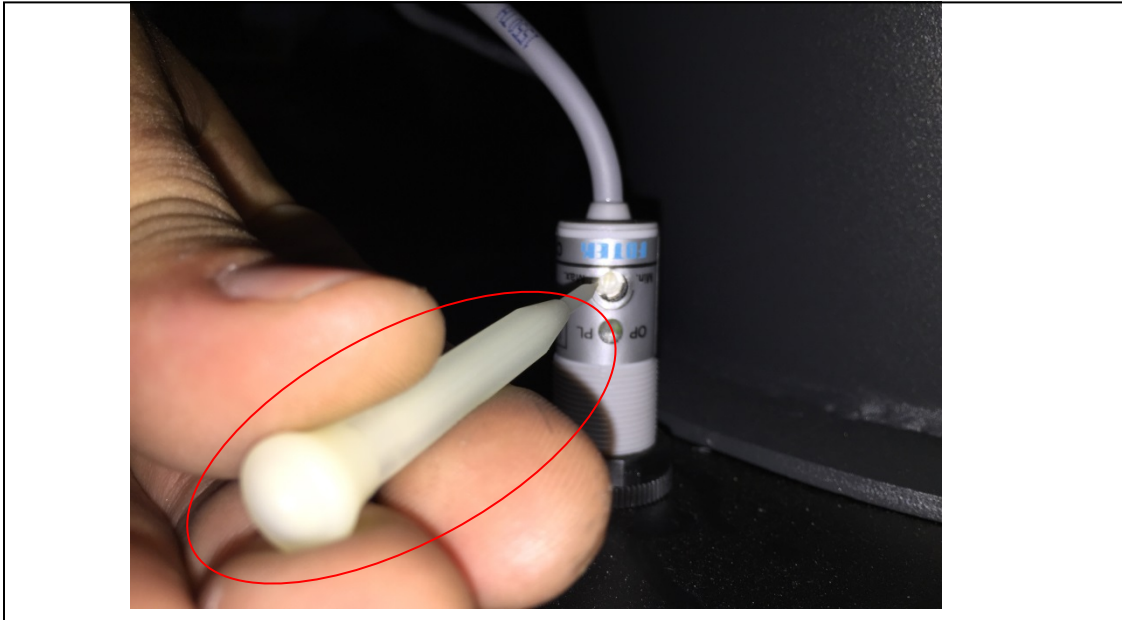

Step Twenty Five: Using the white plastic pin, insert the sharp point into the top end of the proximity sensor that is on top of the drum lid. You will find a small hole to on top where you can turn clockwise or anti-clockwise.

※Clockwise: Lower dust waste level in drum (Less full drum)

※Anti-clockwise: Higher dust waste level in drum (Fuller drum)



LAGUNA

Step Twenty Six: Assemble the Octagon drum. Locate the drum base panel, which is stamped, it does not matter which side faces inside, and secure the (4) 3" wheels using (8) 3/8"OD23*2t flat washers and (4) 3/8" hex nuts.. Use the flat wrench provided to fasten tightly.

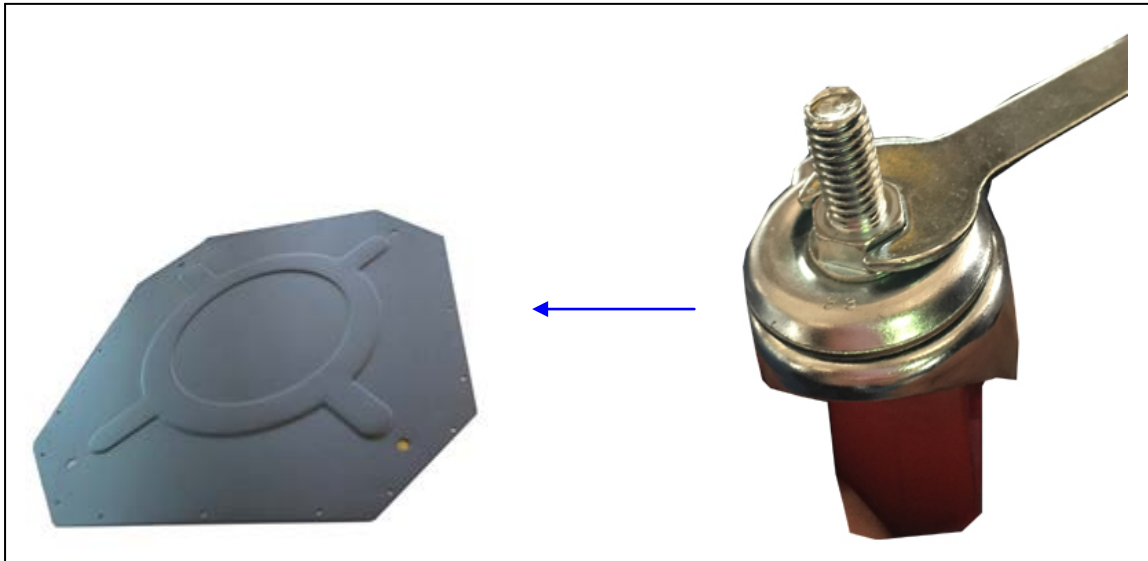

Step Twenty Seven: Take the Octagon drum side panels and assemble together, secure with (40) M4*12mm sheet metal thread bolts. Take note of the left and right panels; do not assemble the incorrect sides. Refer to the next step..



LAGUNA

Step Twenty Eight: The panels have labels R and L on them to show you which panels should be bolted together to prevent any confusion. Please assemble them together per photo below.



Step Twenty Nine: Both the left and right side lift panels have three bolt holes on them. Take the matching side plate and secure to the outside of the panel. (Photo shown is the inside of the panel) using (6) 1/4"*1/2" carriage bolts, (6) 1/4"*OD19*2t flat washers and (6) 1/4" hex nuts.

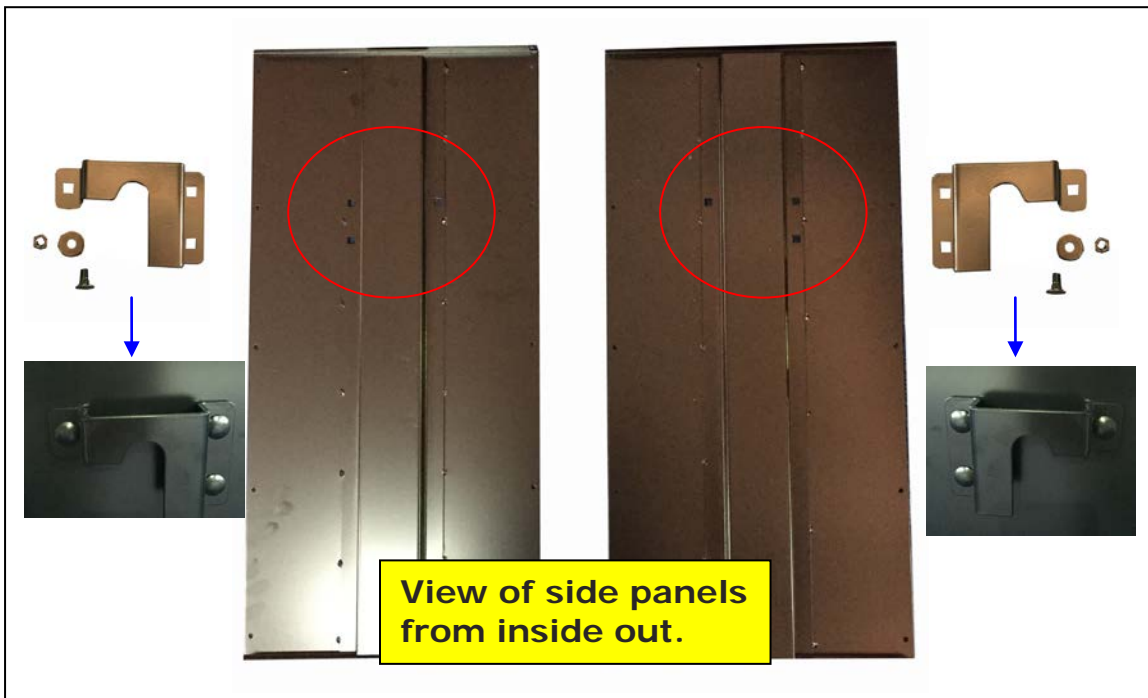

LAGUNA

Step Thirty: Take the Octagon base panel with wheels and secure on to the bottom of the drum using M4*12mm sheet metal thread bolts



Step Thirty One: Take the plastic bolt end caps to cover all the bolt ends on the inside of the Octagon drum using (40) plastic end caps. This step is necessary to prevent any injuries caused by the sharp end of the bolts.



LAGUNA

Step Thirty Two: Once completing the assembly, apply silicone to the inside of the drum including the base to seal and prevent air leakages.



Step Thirty Three: Attach the handles to the top and bottom end on the front panel with the window display using (4) flat head Philip bolt, (4) 5/16" * OD23 * 2t flat washers and (4) 5/16" hex nuts.



LAGUNA

Step Thirty Four: Attach the rubber gasket to the top inner edges of the Octagon drum. The wider end of the gasket goes up. You will need tin snips to trim any excess rubber gasket after completing the seal.

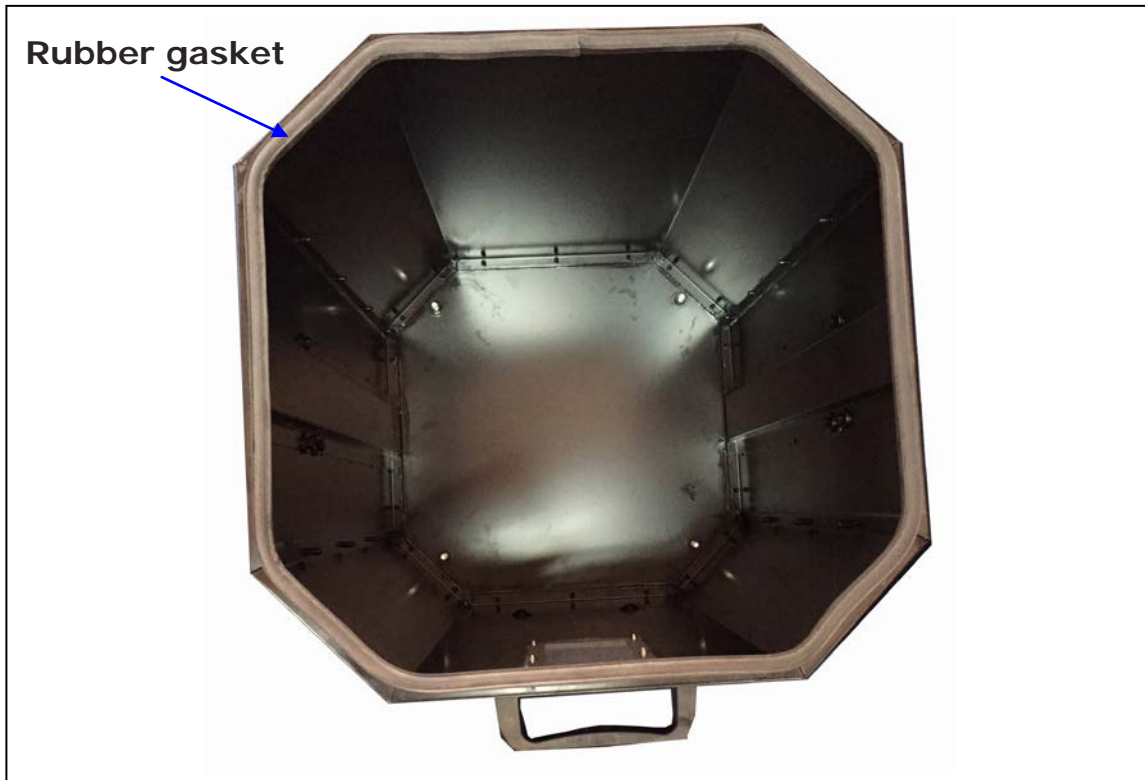

Step Thirty Five: Place the vacuum suction ring inside before inserting the plastic bag in the Octagon drum.

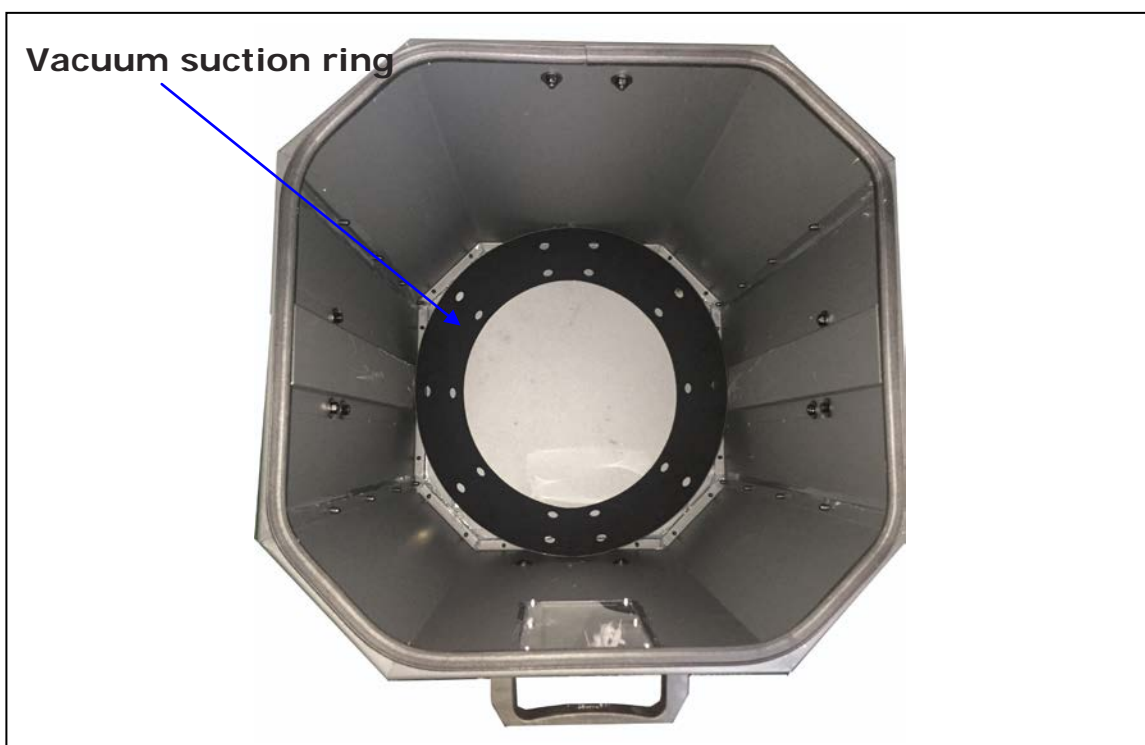

LAGUNA

Step Thirty Six: Insert the plastic bag inside the Octagon drum. Open and spread out the plastic bag to the corners and edges



Step Thirty Seven: Lift the foot peddle bar. Align the Octagon drum window to the center point of the drum lid and push the drum in. Lower the foot peddle bar to seal the drum tight for normal machine operation.



LAGUNA

Step Thirty Eight: Make sure when aligning the drum that both the left and right side lift plates are over the topping on the foot peddle bar assembly before lifting the foot peddle bar up. When not aligned, the drum will not be fully sealed and will interfere with the air flow.

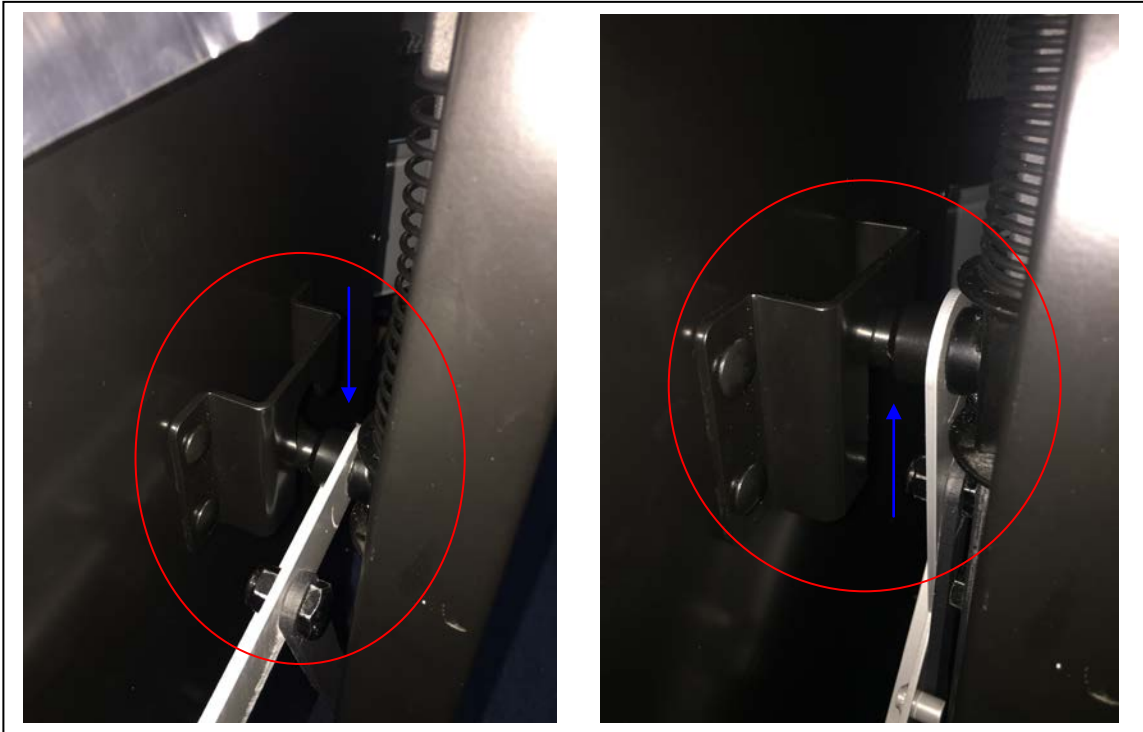

Step Thirty Nine: Remove the control panel by loosening the six bolts holding it to the panel. Secure the two handles to the control panel using (4) M4*6mm philip hd bolts.

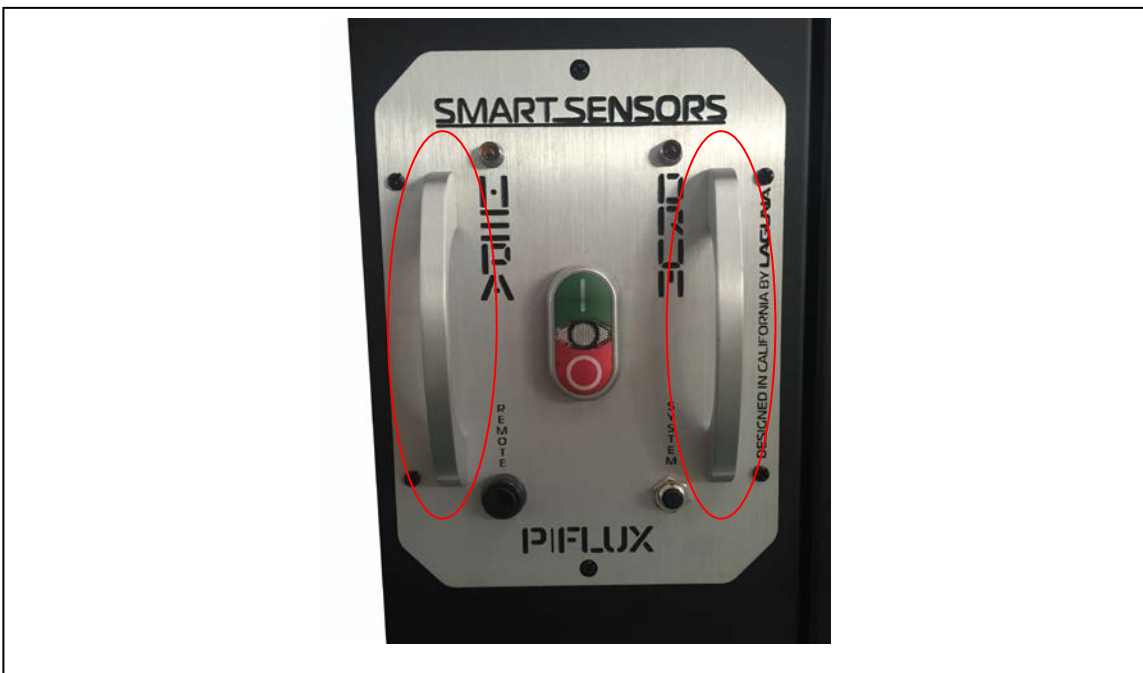

LAGUNA

Step Forty: Apply foam tape to the hole on the dust chute before securing the pressure switch using (4) M4*12MM sheet metal thread bolts.



Step Forty One: Locate the $\text{Ø}1\text{-}1/4\text{'}$ *230mm black flex hose and two $\text{Ø}1\text{-}1/4\text{'}$ hose clamps in the hardware box. Connect the one end of the flex hose to the vacuum suction tube which is located on the top end of the cyclone cone. Connect the other end of the flex hose to the octagon drum lid vacuum tube which is located on the back end of the drum lid closest to the canister filter. Secure both ends with the hose clamps provided.

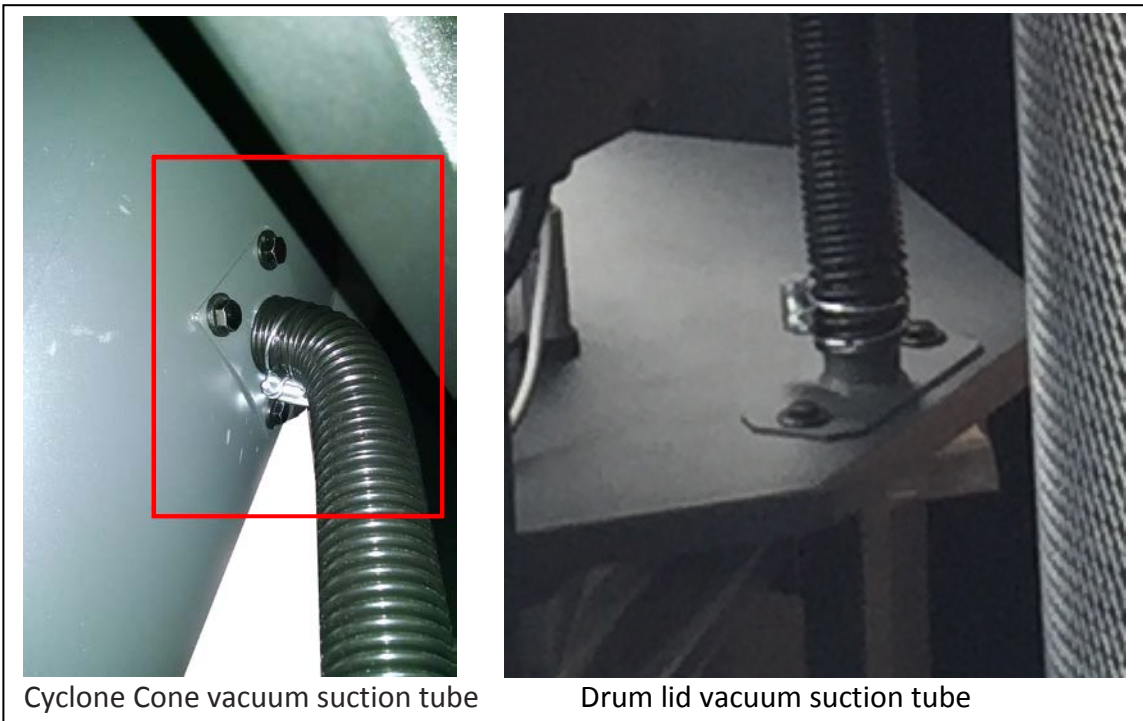

LAGUNA

Step Forty Two: If you do not want to use a plastic bag inside the octagon collection drum, you need to block off the negative pressure. There is a little pack containing the items needed to do this. You will also need take the (4) 1/4" x 1/2" carriage bolts, (4) 1/4" x OD19 x 2t flat washers and (4) 1/4" hex nuts that were securing the vacuum suction pipe to assemble the cover plates. The vacuum suction pipe on the drum will be removed for this. It will not have a purpose if you block off the negative pressure.

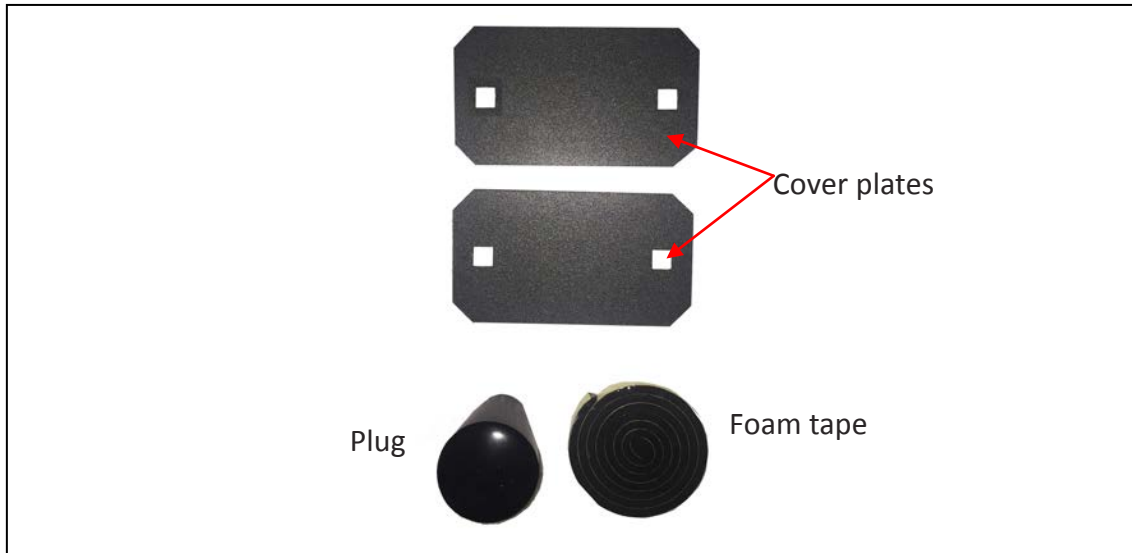

Step Forty Three: Remove the vacuum suction pipe from the drum by loosening the (4) 1/4" x 1/2" carriage bolts, (4) 1/4" x OD19 x 2t flat washers and (4) 1/4" hex nuts mentioned in the previous step. There will be 2 sets from the top and 2 sets from the bottom of the vacuum suction pipe.



LAGUNA

Step Forty Four: Take the one of the cover plates, (2) 1/4"*1/2" carriage bolts, (2) 1/4"*OD19*2t flat washers and (2) 1/4" hex nuts and secure the cover plate to the opening on the top of the drum. For the bottom holes do the same, but first use foam tape to cover the square opening before bolting on the cover plate.

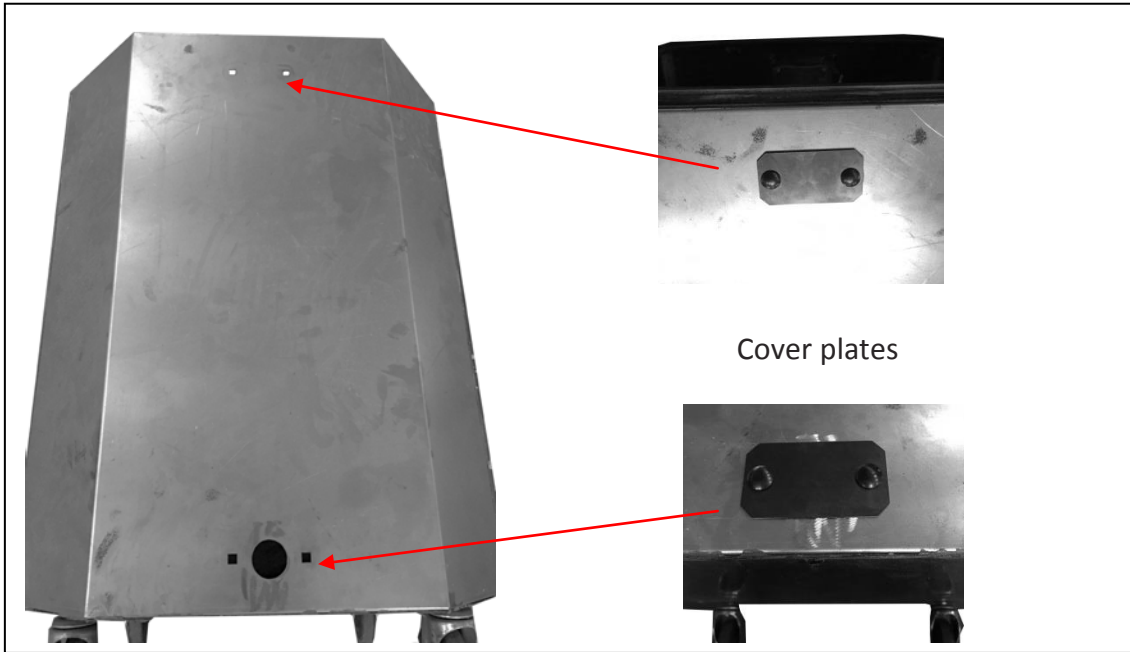

Step Forty Five: Remove the flex hose and clamps from the cyclone cone in step forty one. Locate the plug provided inside the hardware box and attach over the vacuum suction tube as shown in the picture on the right below.

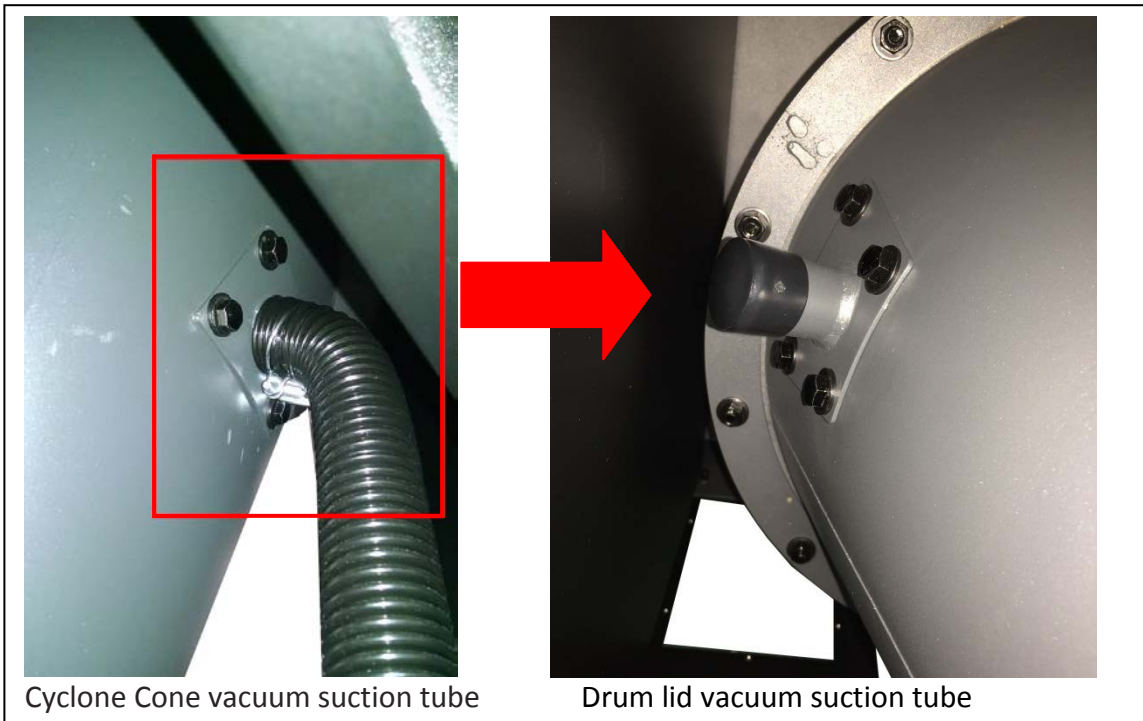

LAGUNA

Step Forty Six: All the assembly steps have been completed.



MAINTENANCE PROCEDURES

CLEANING THE FILTER

To ensure proper operation of this Mobile Dust Cyclone, the HEPA canister filter must have adequate air flow. This means the filter must be regularly maintained by carefully blowing the filter clean using compressed air and an air gun to release built-up particulates trapped between the filter pleats.

For heavy duty users, it is recommended to use compressed air on a regular basis to maintain maximum filtration efficiency and longer life span of the filter.

1. Keep your cyclone switched on and operating; open both sides of the Canister filter shield doors. Connect the Ø4" flex hose from the cyclone to the Ø4" hook up on the canister end cap.



2. While the cyclone is collecting the dust from inside the canister end cap; use compressed air and an air gun and blow the outer surface of the canister.
3. After cleaning the filter with the compressed air gun, follow the steps in the next section to remove the end cap to empty out any dust left inside.



EMPTYING THE CANISTER END CAP

Periodically check the canister end cap, if it is more than one third full, it is recommended that you empty it.

NOTE: If the canister end cap gets too full, the dust particulates may be recirculated back into the canister filter obstructing air flow and exposing the user to potentially harmful particulates.

1. Release the (4) latches around the canister end cap to remove..
2. Empty and re-attach using the latches.

EMPTYING THE DRUM

Periodically inspect the contents of the drum and empty as needed. To inspect the contents of the drum:

1. Raise the drum foot peddle bar to lower the drum to the floor.
2. Roll it away from the machine, inspect and empty as needed.

ROUTINE INSPECTION

It is a good idea to routinely inspect any quality woodworking tool in order to keep it in optimum condition. This includes inspecting all hardware for tightness, ensuring the filter is clean, and cleaning debris and grime from any surfaces and moving parts.



TROUBLESHOOTING GUIDE

Symptom	Possible Cause	Possible Solution
Machine does not start or a breaker trips.	Power supply switched OFF or is faulty.	Ensure power supply is ON and has the correct voltage.
	Wall fuse/circuit breaker is blown/tripped.	Ensure adequate circuit size; install inlet restrictor, replace weak breaker.
	Faulty remote control.	Replace batteries; ensure unobstructed line-of-sight and signal range.
	Remote receiver is faulty.	Inspect receiver circuit board; replace if faulty.
	Incorrectly wired motor connection.	Rewire or call certified service technician or electrician.
	On-board circuit breaker is tripped.	Allow motor to cool, improve ventilation, press reset button.
	Wiring is open/has high resistance.	Check for broken wires or poor connections, repair as necessary.
	Faulty power switch.	Replace switch.
Excessive vibration or noise during operation.	Motor is at fault.	Test/repair/replace.
	Loose component.	Inspect and tighten all bolts/nuts.
	Loose or broken motor mount.	Tighten or replace as needed.
	Motor fan hitting fan cover.	Check fan and cover; replace as needed.
	Bad motor bearings.	Rotate shaft manually, check for grinding or loose shaft, replace bearings if needed.

LAGUNA

<p>Loud, repetitive noise, or excessive vibration coming from cyclone</p>	<p>Machine is on uneven surface.</p> <p>Damaged/Unbalanced impeller.</p> <p>Loose connections.</p> <p>Impeller is loose.</p> <p>Motor fan hitting fan cover.</p>	<p>Stabilize on a flat surface.</p> <p>Inspect impeller for dents, bends, loose fins. Replace if needed.</p> <p>Check and re-tighten all fasteners.</p> <p>Replace the motor and impeller.</p> <p>Check fan and cover; replace as needed.</p>
<p>Dust cyclone does not adequately collect dust or chips; poor performance.</p>	<p>Canister end cap is full.</p> <p>Filter is dirty.</p> <p>Restricted duct line.</p> <p>Suction route is too long or has too many sharp bends.</p> <p>Wet lumber is clogging ducts.</p> <p>Leaks in the duct work or too many open ports.</p> <p>Inadequate velocity in the main suction line.</p> <p>Wrong size ducting/ports used.</p>	<p>Empty canister end cap.</p> <p>Clean filter.</p> <p>Clean inlet splitter.</p> <p>Move machine closer to the point of suction, and rerun ducts to eliminate sharp bends.</p> <p>Use lumber with less than 20% moisture content.</p> <p>Repair all duct leaks and close any ports not being used.</p> <p>Increase velocity by opening 1 or 2 more blast gates to different branch lines.</p> <p>Re-size and re-install ducts and fittings.</p>
<p>Sawdust being blown into the air from the dust cyclone</p>	<p>Band clamp or end cap is not secure.</p> <p>Loose or damaged seals.</p>	<p>Re-install ensuring a tight fit.</p> <p>Replace seals and gaskets.</p>

Parts Breakdown

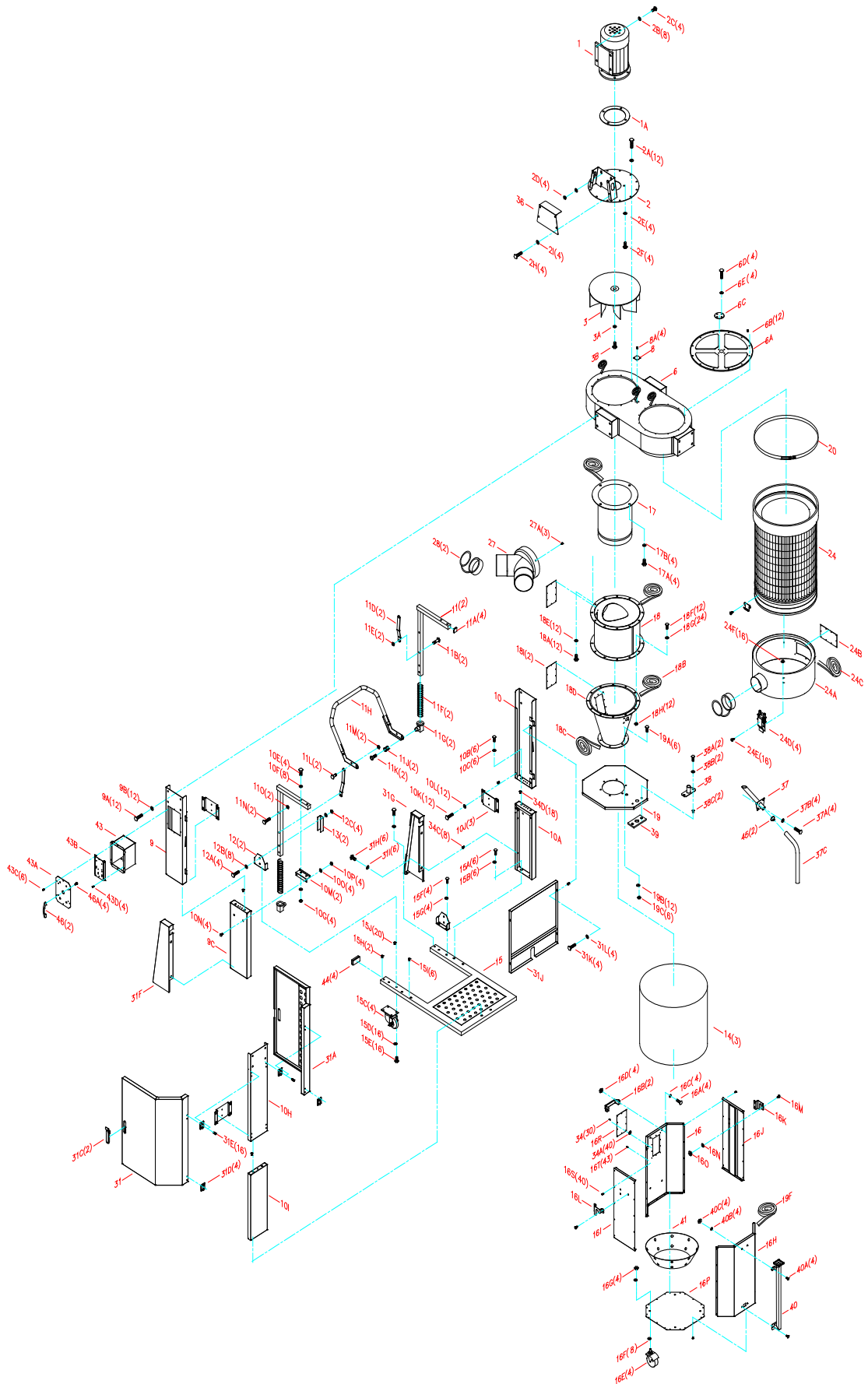

SECTION A (Close up view)

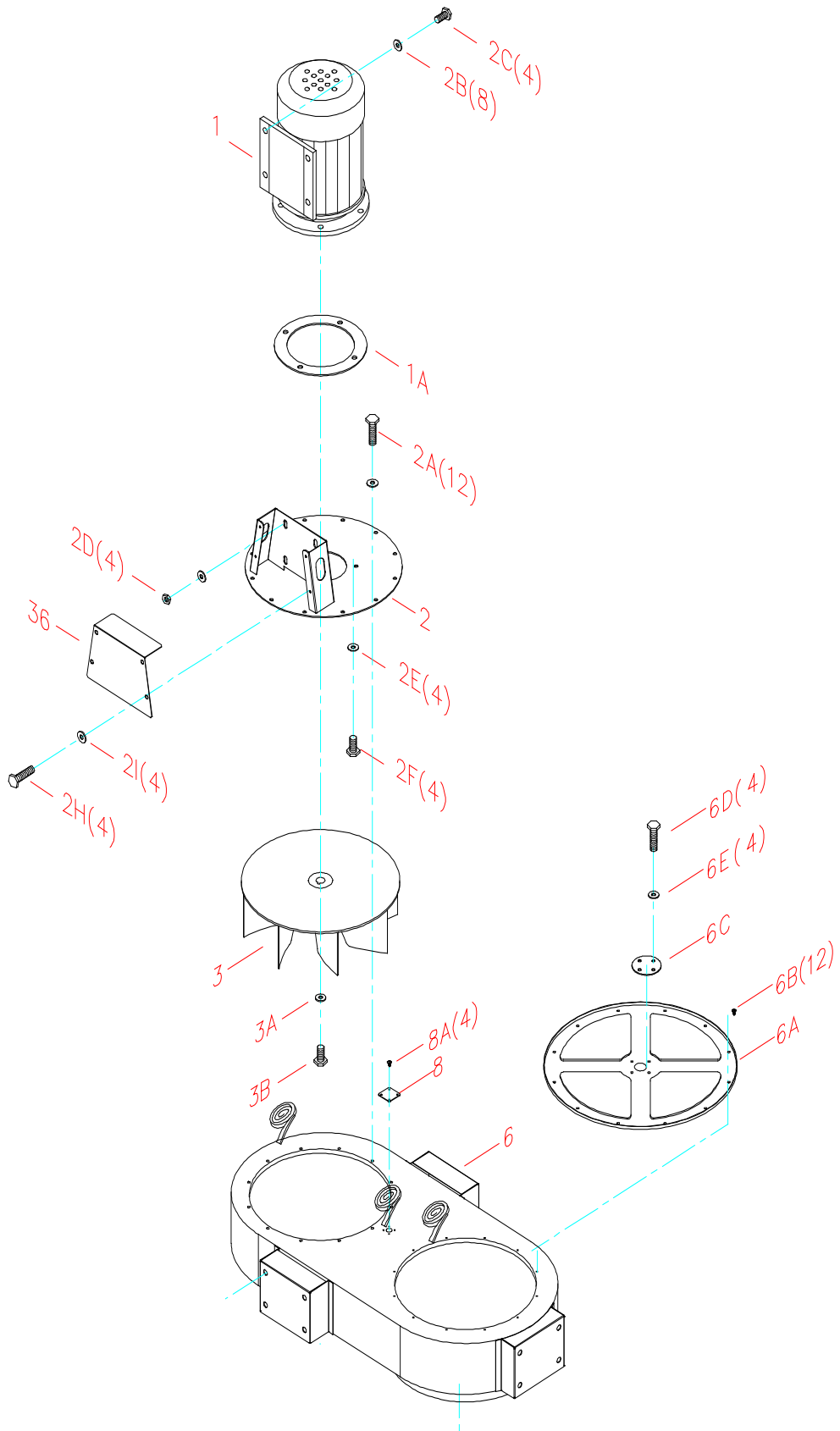

SECTION B (Close up view)

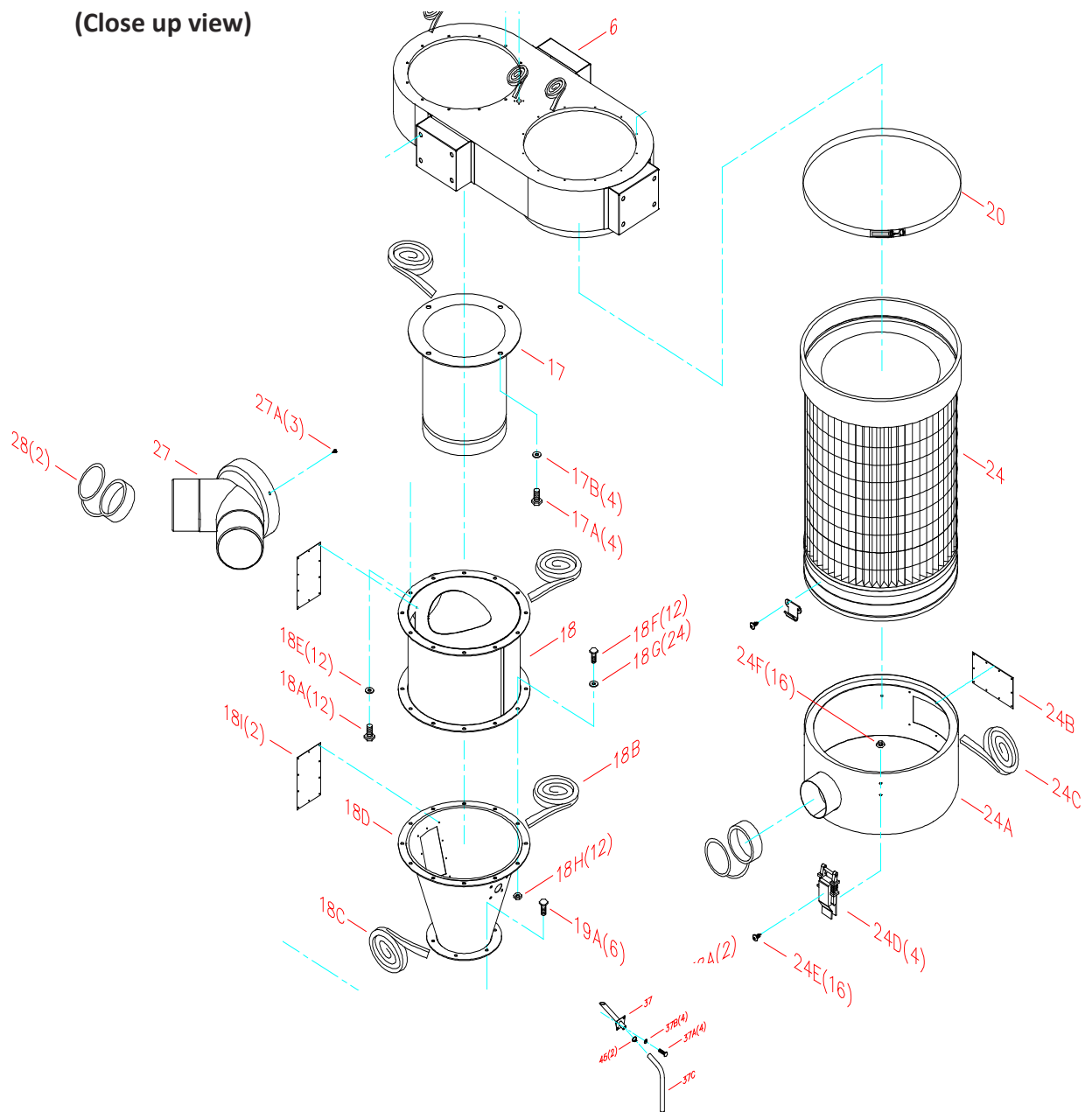

Part List

Ref No	Part Name	Description	Q'TY
1	MOTOR	1.5HP/240V/50Hz/1Phase	1
1A	MOTOR GASKET		1
2	MOTOR SUPPORT BASE		1
2A	HEX LOCK BOLT	5/16"*5/8"	12
2B	FLAT WASHER	3/8"*OD23*2t	8
2C	HEX BOLT	3/8"*1"	4
2D	HEX NUT	3/8"	4
2E	FLAT WASHER	5/16"*OD18*2t	4
2F	HEX BOLT	5/16"*3/4"	4
2G	SWITCH PLATE		1
2H	HEX BOLT	1/4"*3/4"	4
2I	FLAT WASHER	1/4"*OD19*1t	4
2J	LOCK WASHER	3/8"	4
3	FAN	Ø340	1
3A	FLAT WASHER	5/16"*OD30*3t	1
3B	HEX BOLT	5/16"*3/4"	1
6	DUST CHUTE		1
6A	CANISTER COVER PLATE		1
6B	SHEET METAL THREAD BOLT	3/16"*1/2"	12
6C	SEAL PLATE		1
6D	HEX BOLT	1/4"*3/4"	4
6E	FLAT WASHER	1/4"*OD19*1t	4
8	COVER PLATE		1
8A	SHEET METAL THREAD BOLT	M4*12mm	4
9	TOP UPRIGHT SUPPORT	TWO DOT	1

LAGUNA

Ref No	Part Name	Description	Q'TY
9A	HEX BOLT	5/16"*3/4"	12
9B	FLAT WASHER	5/16"*OD18*2t	12
9C	LOWER UPRIGHT SUPPORT	TWO DOT	1
10	TOP UPRIGHT SUPPORT	THREE DOT	1
10A	LOWER UPRIGHT SUPPORT	THREE DOT	1
10B	HEX BOLT	5/16"*3/4"	6
10C	FLAT WASHER	5/16"*OD18*2t	6
10E	HEX BOLT	5/16"*3/4"	4
10F	FLAT WASHER	5/16"*OD18*2t	8
10G	HEX NUT	5/16"	4
10H	TOP UPRIGHT SUPPORT	ONE DOT	1
10I	LOWER UPRIGHT SUPPORT	ONE DOT	1
10J	UPRIGHT SUPPORT REINFORCEMENT PLATE		3
10K	HEX BOLT	5/16"*3/4"	12
10L	FLAT WASHER	5/16"*OD18*2t	12
10M	FOOT PEDDLE BAR SUPPORT		2
10N	CARRIAGE BOLT	5/16"*1/2"	4
10O	FLAT WASHER	5/16"OD18*2t	4
10P	HEX NUT	5/16"	4
11	FOOT PEDDLE BAR		2
11A	PLUG	25*25	4
11B	HEX BOLT	3/8"*46mm	2
11D	MOVEABLE SUPPORT BRACE	208*20*21	2
11E	HEX LOCK NUT	3/8"	2
11F	SPRING	Ø42*242L	2
11G	SKID BLOCK		2

LAGUNA

Ref No	Part Name	Description	Q'TY
11H	OCTAGON DRUM FOOT PEDDLE	520*226*350	1
11J	TOPPING	Ø24*30	2
11K	HEX BOLT	M8*30mm	2
11L	HEX BOLT	3/8"*21mm	2
11M	HEX LOCK NUT	3/8"	2
11N	HEX BOLT	3/8"*1-1/2"	2
11O	HEX LOCK NUT	3/8"	2
12	TRIANGULAR SUPPORT PLATE	170*102*28	2
12A	HEX BOLT	5/16"*1-3/4"	4
12B	FLAT WASHER	5/16"*OD18*2t	8
12C	HEX NUT	5/16"	4
13	LOWER SUPPORT PLATE	30*28*98	2
14	PLASTIC BAG	55*95CM	3
15	BASE		1
15A	HEX BOLT	3/8"*3/4"	6
15B	FLAT WASHER	3/8"*OD23*2t	6
15C	SWIVEL CASTER	4"	4
15D	FLAT WASHER	5/16"*OD18*2t	16
15E	HEX BOLT	5/16"*3/4"	16
15F	HEX BOLT	5/16"*3/4"	4
15G	FLAT WASHER	5/16"*OD18*2t	4
15H	RIVET NUT	1/4"	2
15I	RIVET NUT	3/8"	6
15J	RIVET NUT	5/16"	20
16	OCTAGON DRUM FRONT PANEL		1
16A	FLAT HEAD PHILIP BOLT	5/16"*3/4"	4

LAGUNA

Ref No	Part Name	Description	Q'TY
16B	HANDLE		2
16C	FLAT WASHER	5/16"*OD23*2t	4
16D	HEX NUT	5/16"	4
16E	DRUM CASTER	3"*3/8"	4
16F	FLAT WASHER	3/8"*OD23*2t	8
16G	HEX NUT	3/8"	4
16H	OCTAGON DRUM BACK PANEL		1
16I	OCTAGON DRUM RIGHT PANEL		1
16J	OCTAGON DRUM LEFT PANEL		1
16K	LEFT SIDE PLATE		1
16L	RIGHT SIDE PLATE		1
16M	CARRIAGE BOLT	1/4"*1/2"	6
16N	FLAT WASHER	1/4"*OD19*2t	6
16O	HEX NUT	1/4"	6
16P	OCTAGON DRUM BASE PANEL		1
16R	WINDOW		1
16S	THREAD BOLT	M4*12mm	40
16T	PLASTIC BOLT END CAP		43
17	INTAKE CYLINDER		1
17A	HEX BOLT		4
17B	FLAT WASHER	5/16"*OD18*2t	4
18	CYCLONE BARREL		1
18A	HEX BOLT	5/16"*3/4"	12
18B	FOAM TAPE	3*6mm*10M	1
18D	CYCLONE FUNNEL		1
18E	FLAT WASHER	5/16"*OD18*2t	12

LAGUNA

Ref No	Part Name	Description	Q'TY
18F	HEX BOLT	5/16"*3/4"	12
18G	FLAT WASHER	5/16"*OD18*2t	24
18H	HEX NUT	5/16"	12
18I	WINDOW		2
19	OCTAGON DRUM LID		1
19A	HEX BOLT	5/16"*3/4"	6
19B	FLAT WASHER	5/16"*OD18*2t	12
19C	HEX NUT	5/16"	6
19D	PLUG	MSP-16	1
19E	NUT	AGL-16	1
19F	RUBBER GASKET	140CM	1
20	BAND CLAMP	Ø400	1
20A	SPRING BAND CLAMP	Ø400	1
24	CANISTER FILTER	Ø400*611L	1
24A	CANISTER END CAP		1
24B	WINDOW		1
24C	FOAM TAPE	5*20mm*1.3M	1
24D	LATCH	98#	4
24E	ROUND HEAD BOLT	3/16"*3/8"	8
24F	NUT	3/16"	8
27	INTAKE MANIFOLD	Ø6" BY Ø4" X 2PORTS	1
27A	SHEET METAL BOLT	M4*12mm	3
28	RUBBER CAP	4"	2
31	CANISTER FILTER SHIELD DOOR		1
31A	CANISTER FILTER SHIELD DOOR		1
31B	RIVET PLATE		4

LAGUNA

Ref No	Part Name	Description	Q'TY
31C	DOOR HANDLE		2
31D	HINGE	CL-209	4
31E	HEX BOLT	M5*10mm	16
31F	COVER PLATE RIGHT		1
31G	COVER PLATE LEFT		1
31H	HEX BOLT	1/4"*3/4"	6
31I	FLAT WASHER	1/4"*OD19*1t	6
31J	CANISTER FILTER SHIELD		1
31K	HEX BOLT	1/4"*3/4"	4
31L	FLAT WASHER	1/4"*OD19*1t	4
34	RIVET	3-2	40
34A	FLAT WASHER	1*8"*OD8*1t	40
34C	RIVET NUT	1/4"	8
34D	RIVET NUT	5/16"	8
36	MOTOR SWITCH SUPPORT BASE COVER PLATE		1
37	CYCLONE FUNNEL VACUUM TUBE		1
37A	HEX BOLT	5/16"*3/4"	4
37B	FLAT WASHER	5/16"*OD18*2t	4
37C	BLACK FLEX HOSE	Ø1-1/4"*230mm	1
38	DRUM LID VACUUM SUCTION TUBE		1
38A	HEX BOLT	1/4"*3/4"	2
38B	FLAT WASHER	1/4"*OD19*1t	2
38C	RIVET	1/4"	2
39	FOAM TAPE	135*69*10mm	1
40	VACUUM SUCTION PIPE		1
40A	CARRIAGE BOLT	1/4"*1/2"	4

LAGUNA

Ref No	Part Name	Description	Q'TY
40B	FLAT WASHER	1/4"*OD19*2t	4
40C	HEX NUT	1/4"	4
41	VACUUM SUCTION RING		1
43	CONTROL BOX		1
43A	CONTROL PANEL	ANODIZED	1
43B	CONTROL PANEL SUPPORT PLATE		1
43C	ROUND HEAD BOLT	M4*10mm	6
43D	PHILIP HD BOLT	M4*6mm	4
44	RUBBER PLUG	30*60mm	2
45	HOSE CLAMP	1-1/4"	2
46	CONTROL PANEL HANDLE		2
46A	PHILIP HD BOLT	M4*6mm	4

**For After Sales & Service:
Charnwood Machinery Ltd
Walker Road, Hilltop Industrial Estate,
Bardon, Leicestershire, LE67 1TU,
United Kingdom
Tel. +44 (0) 1530 516 926
sales@lagunatools.uk
www.lagunatools.uk**